

Großes

Universal-Forschungsmikroskop



Funktionsbeschreibung u. Gebrauchsanleitung



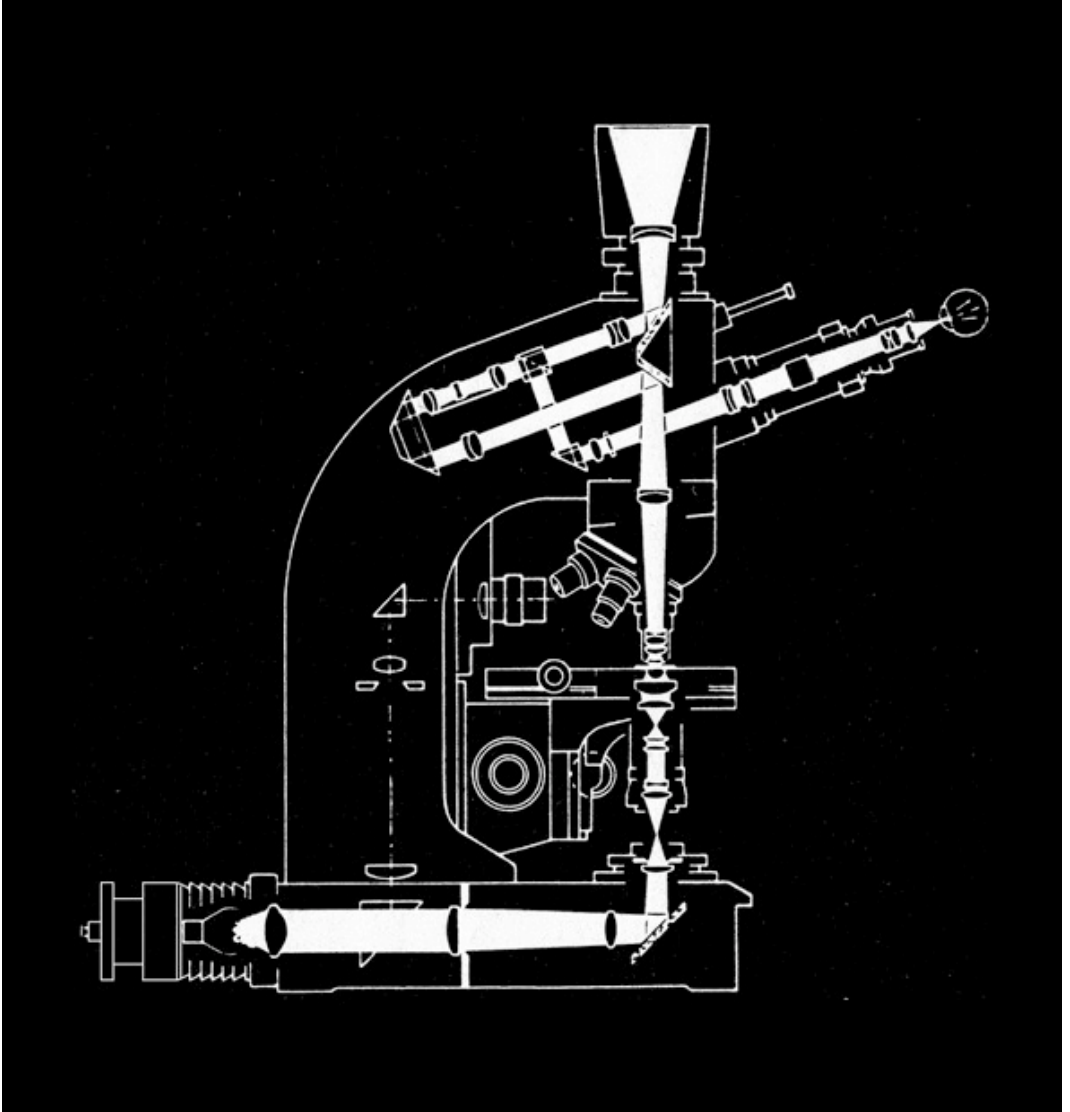

Schema 1

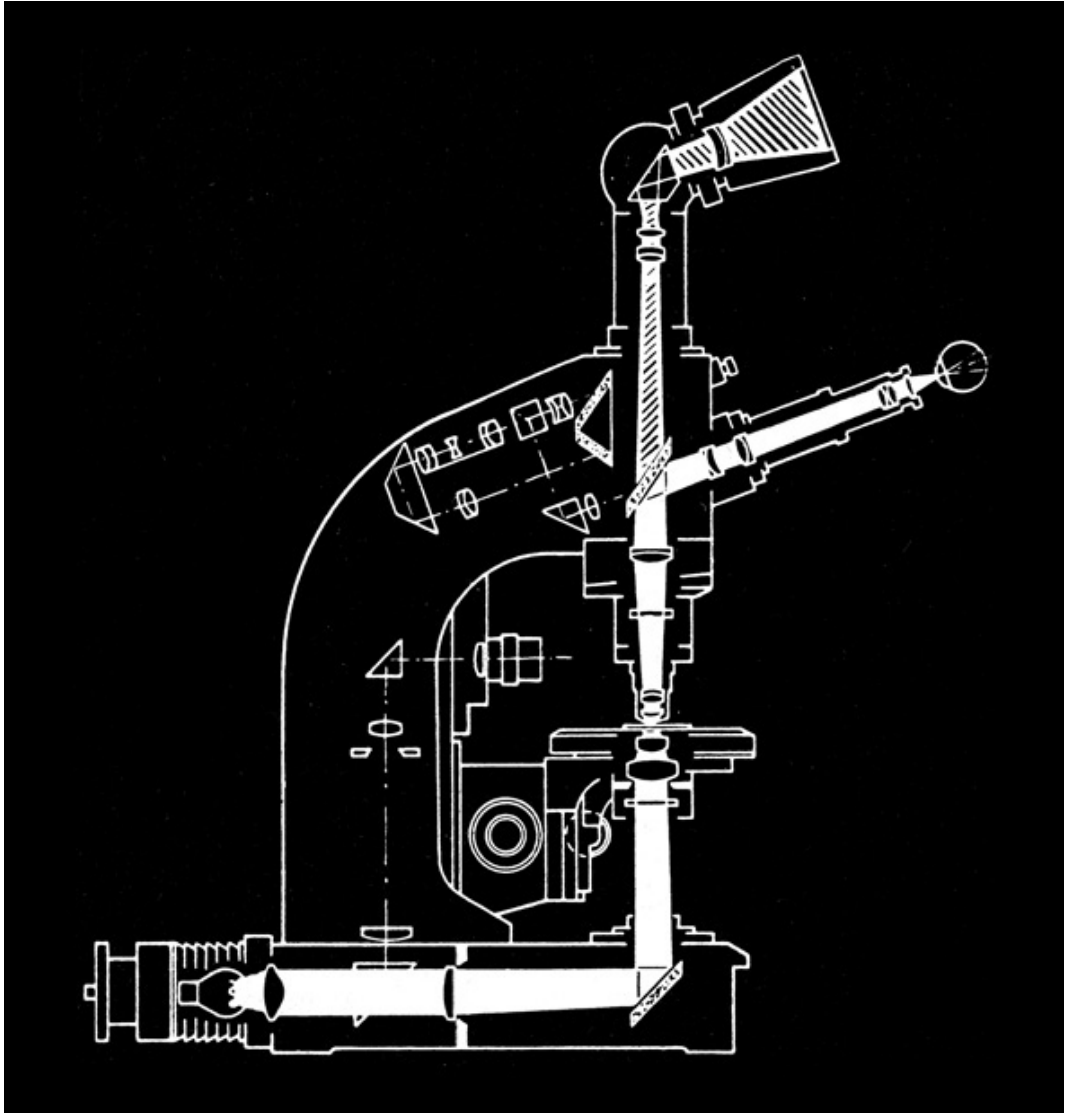

Schema 2

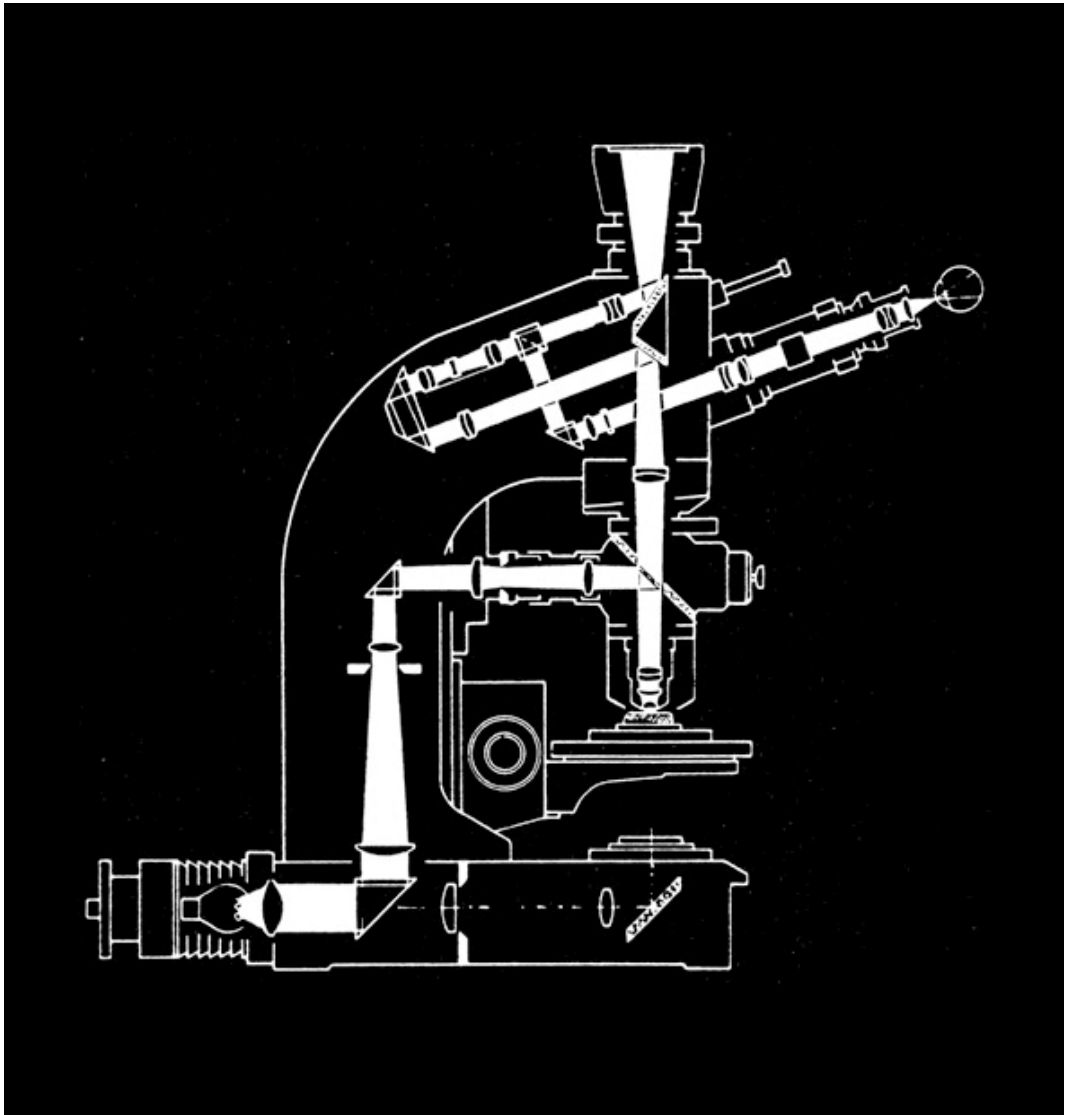

Schema 3

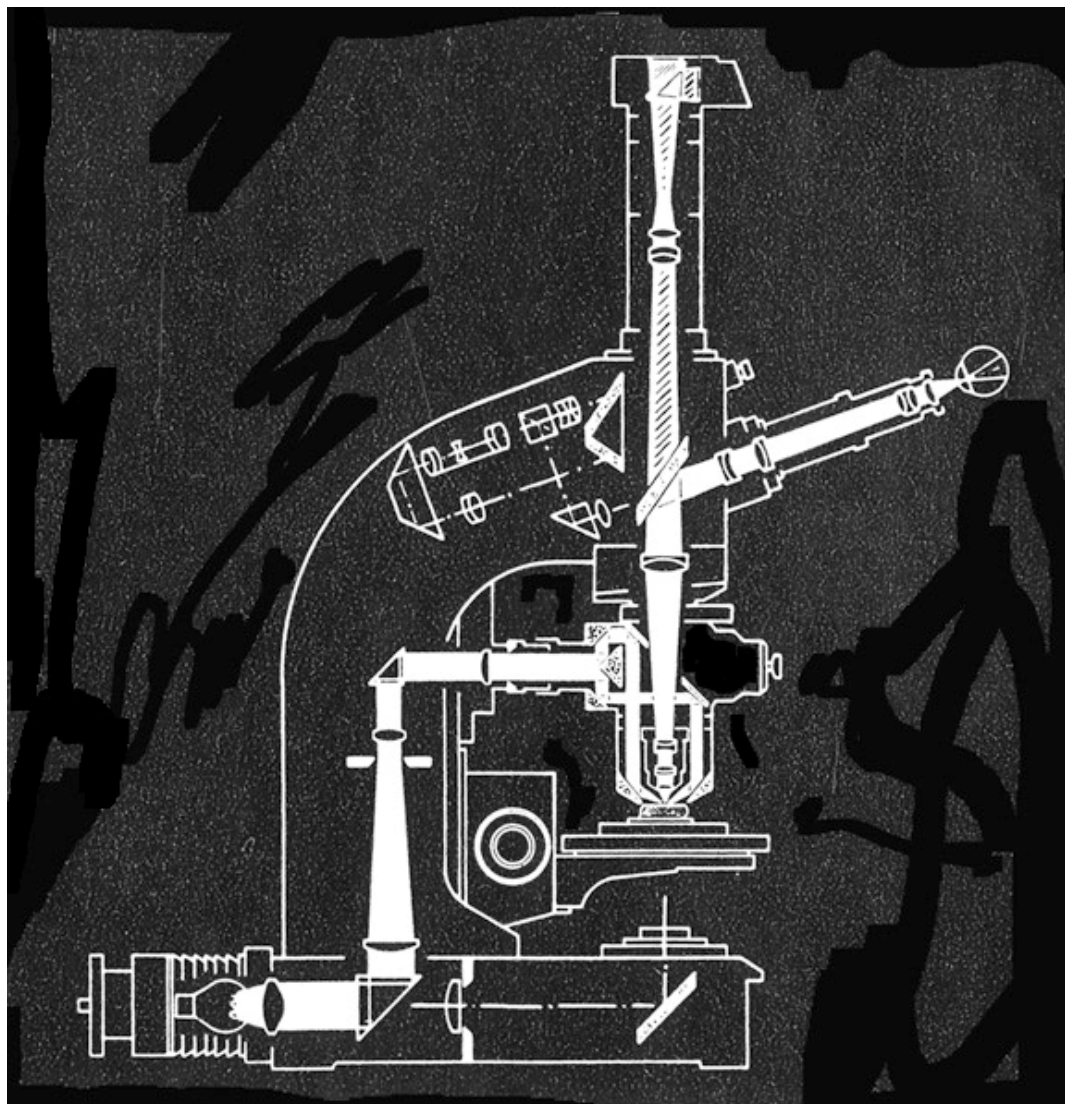

Schema 4



Bild 1



Bild 2

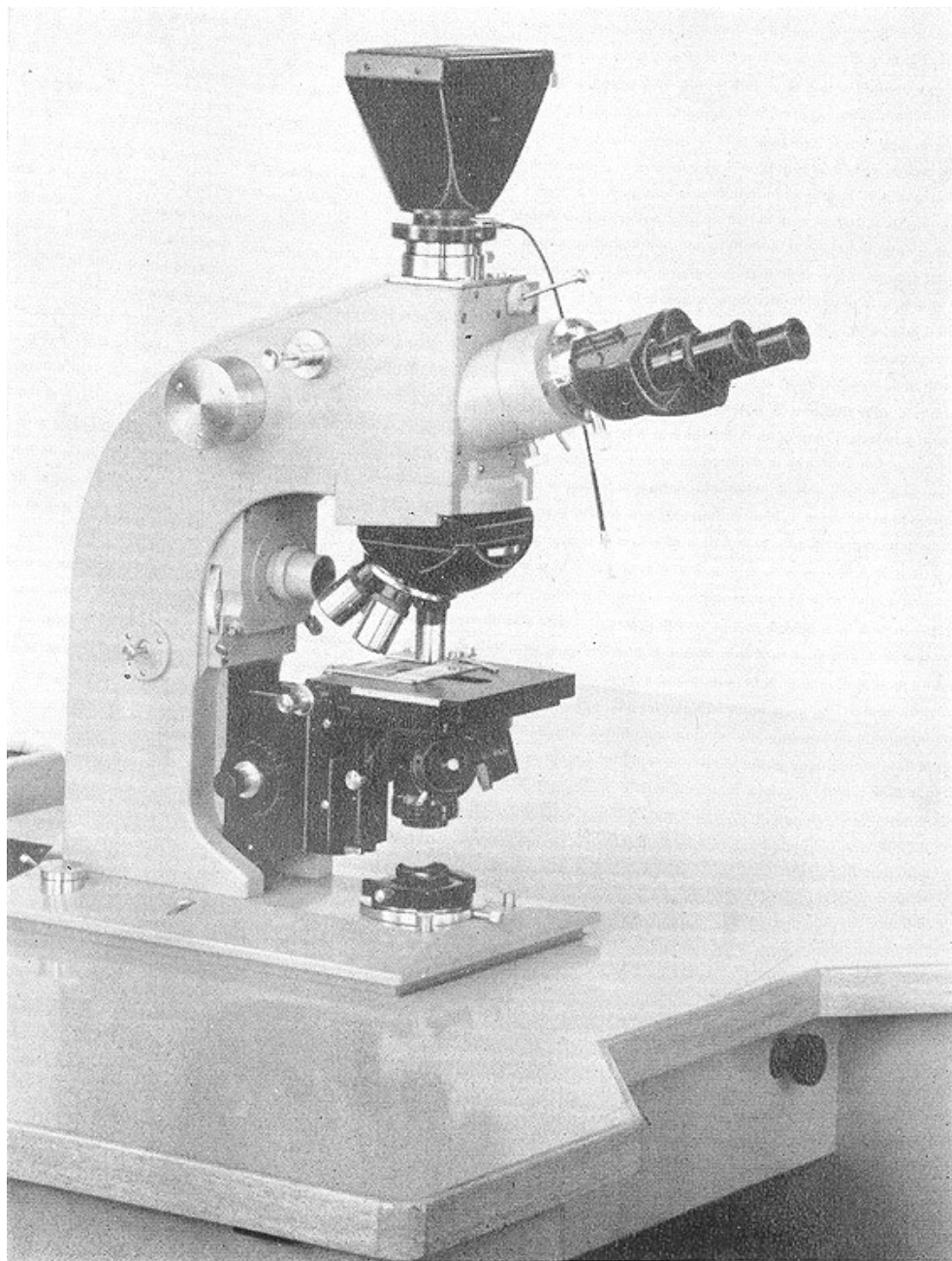

Bild 3

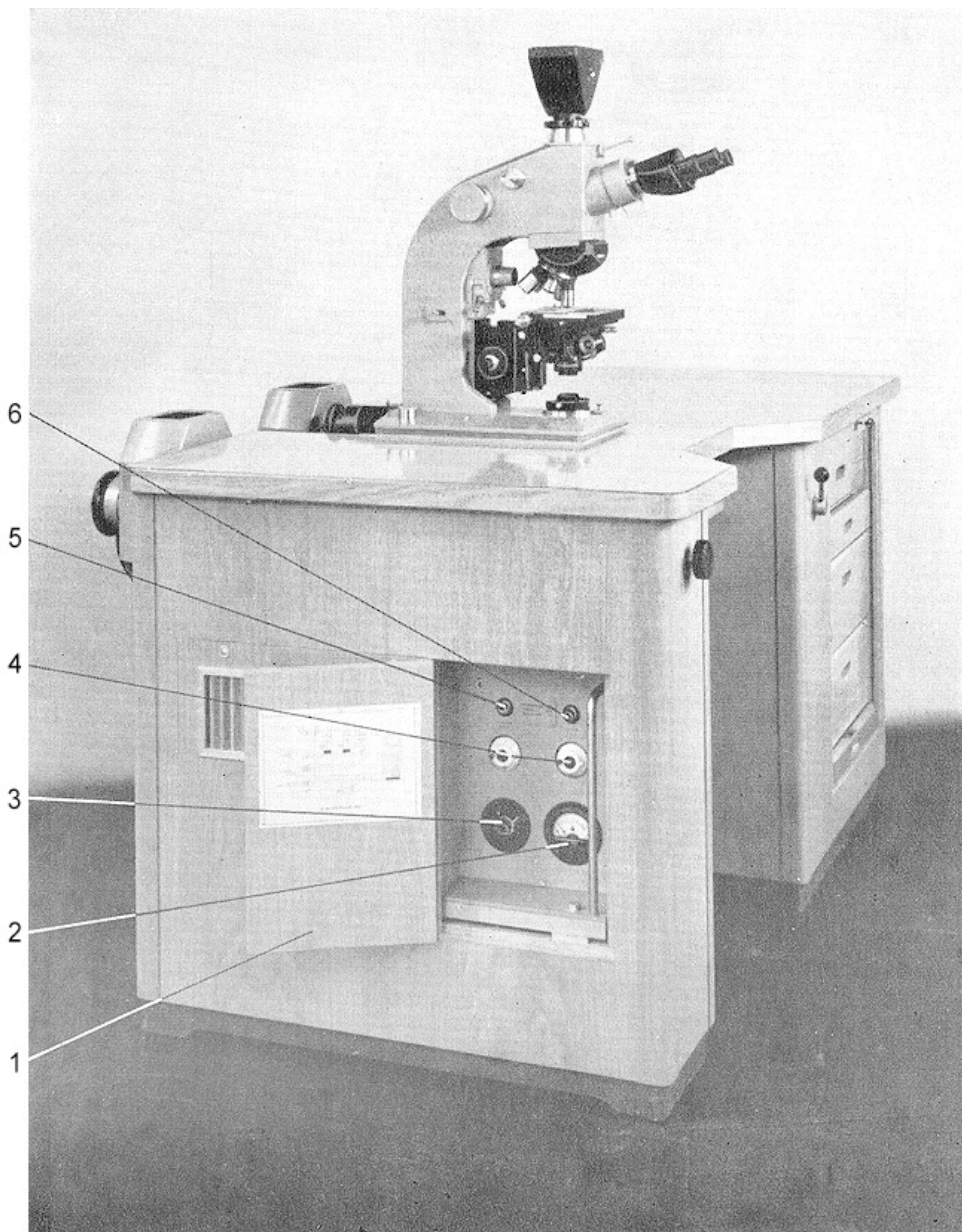

Bild 4

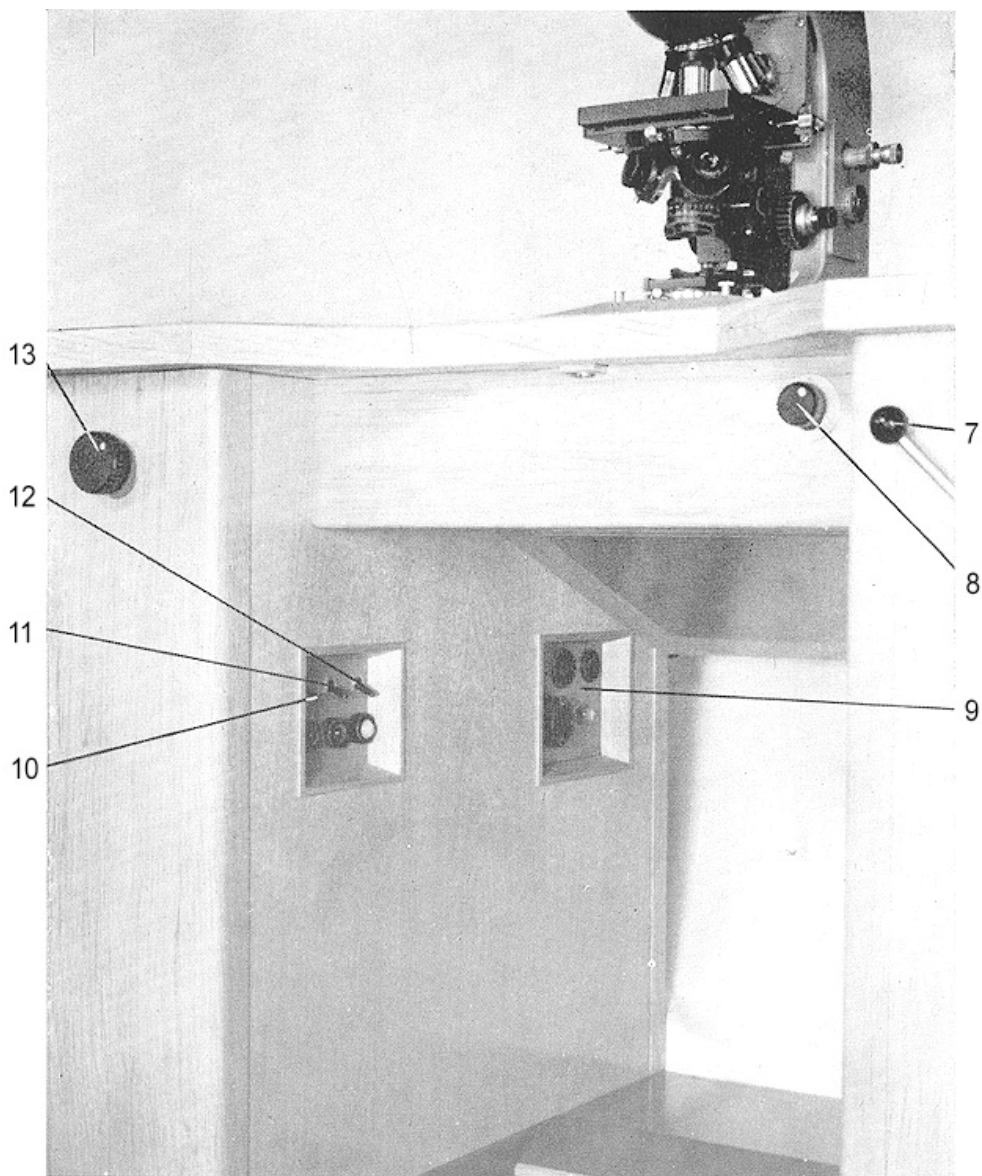

Bild 5



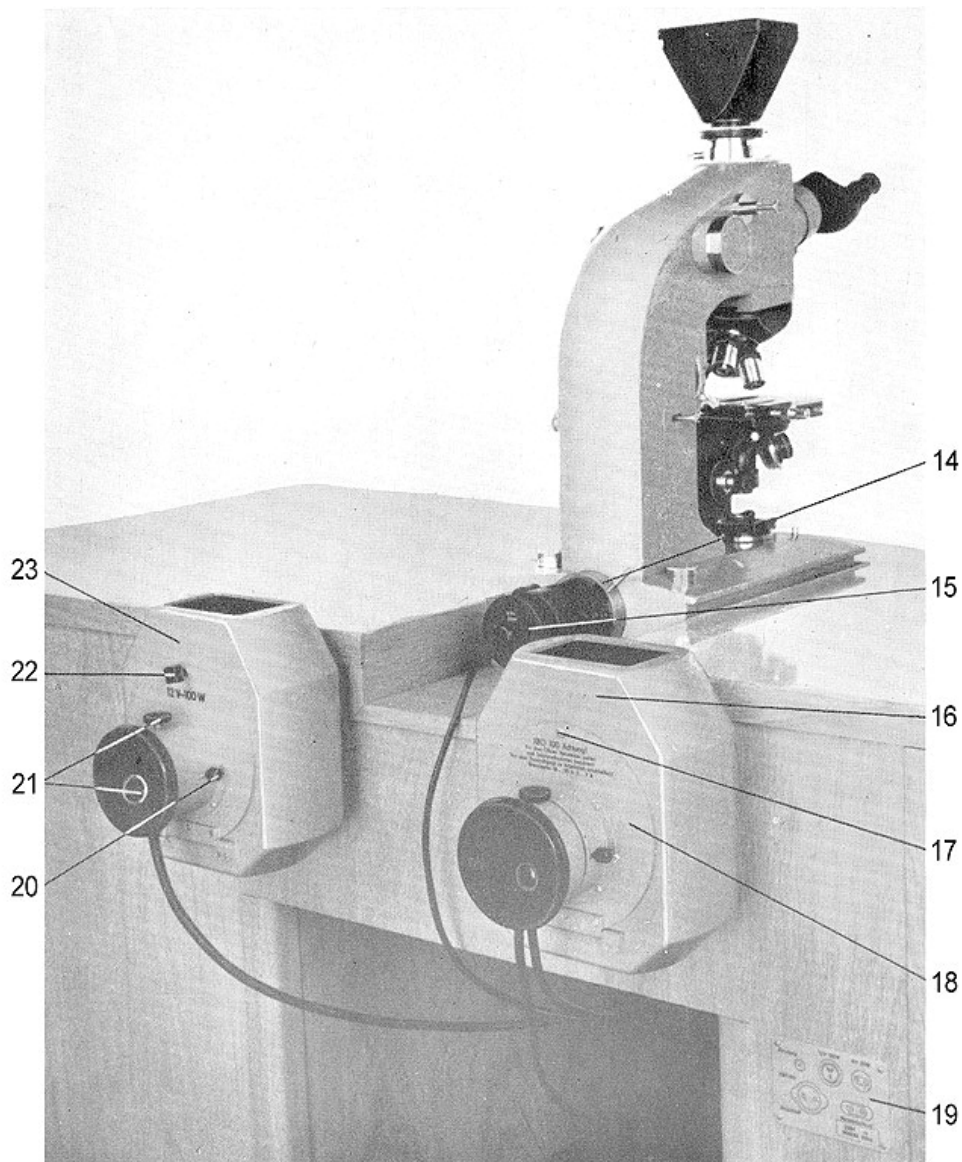

Bild 7

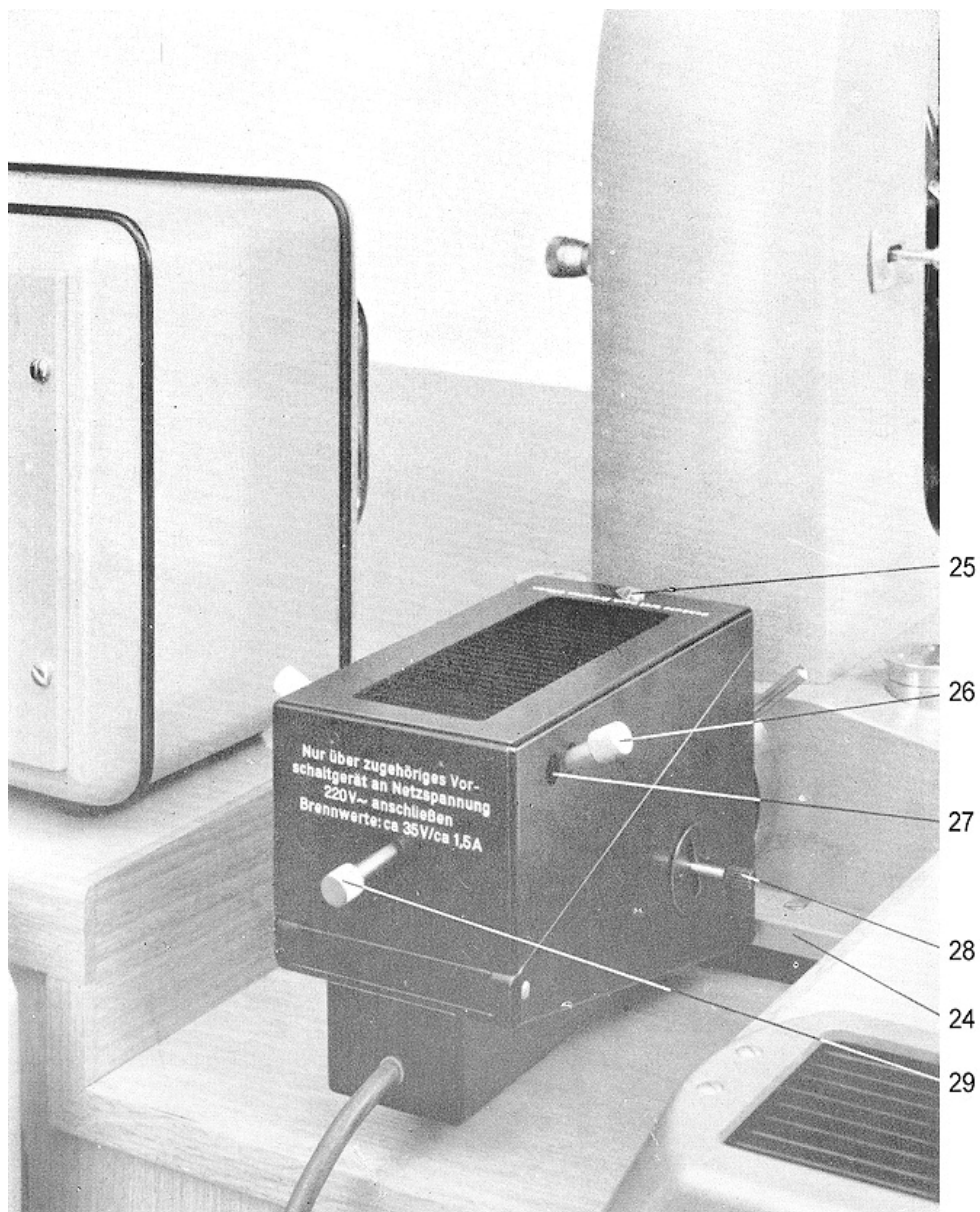
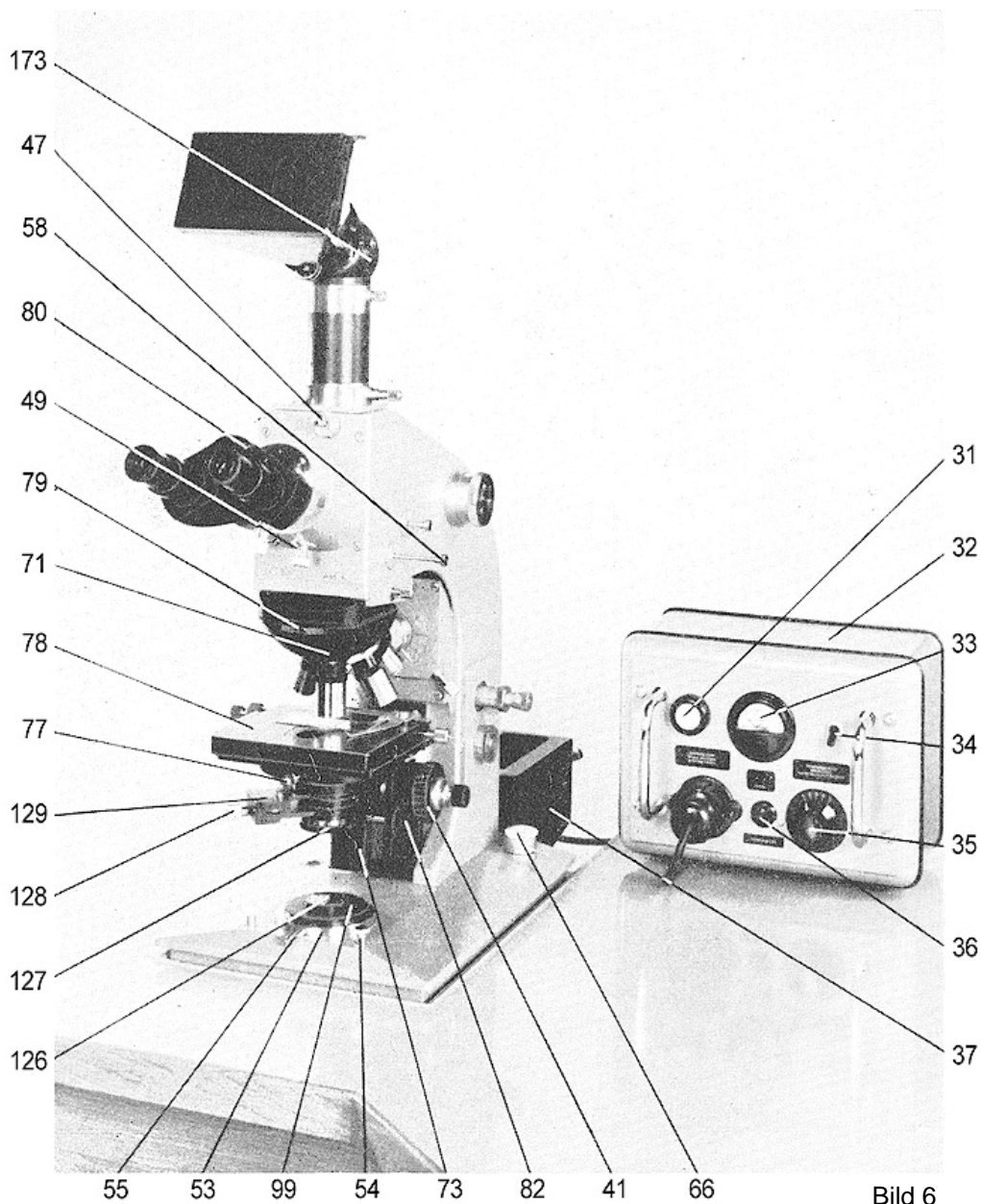

Bild 8

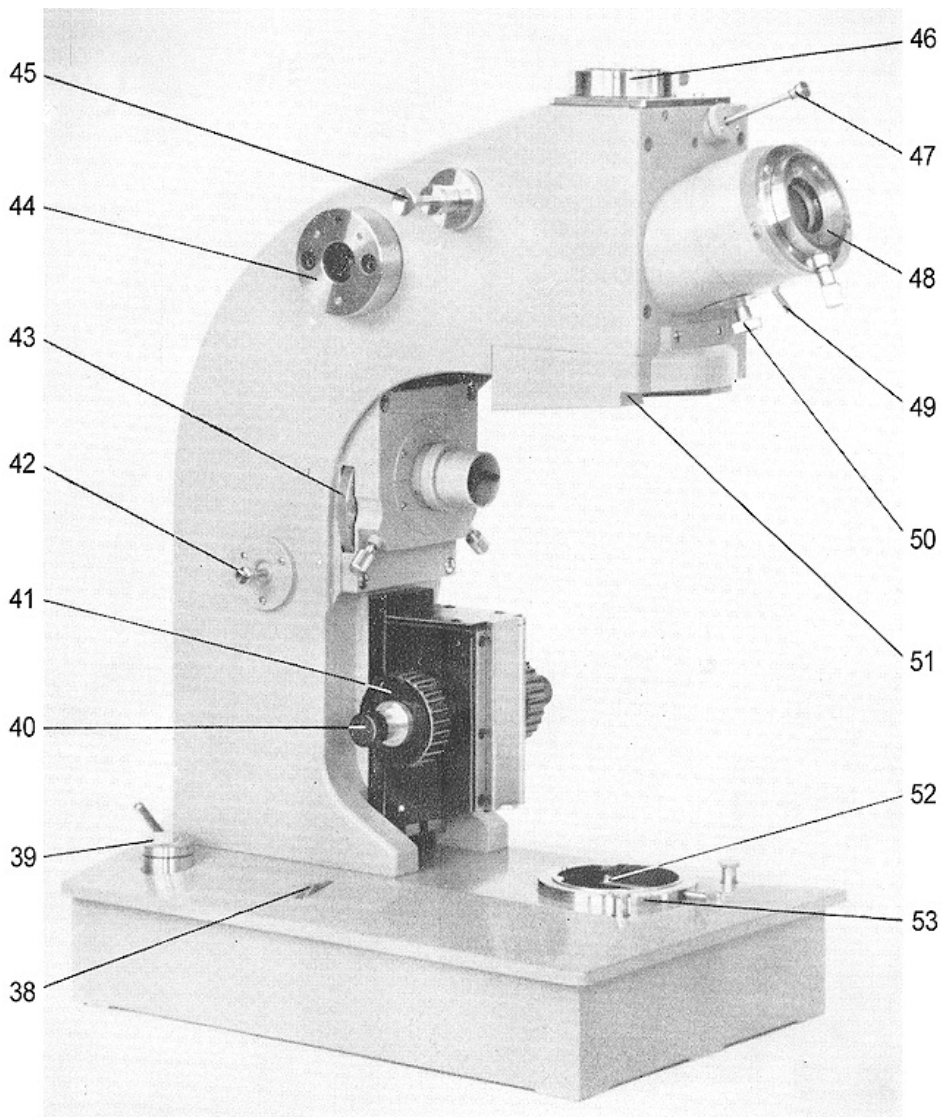

Bild 9

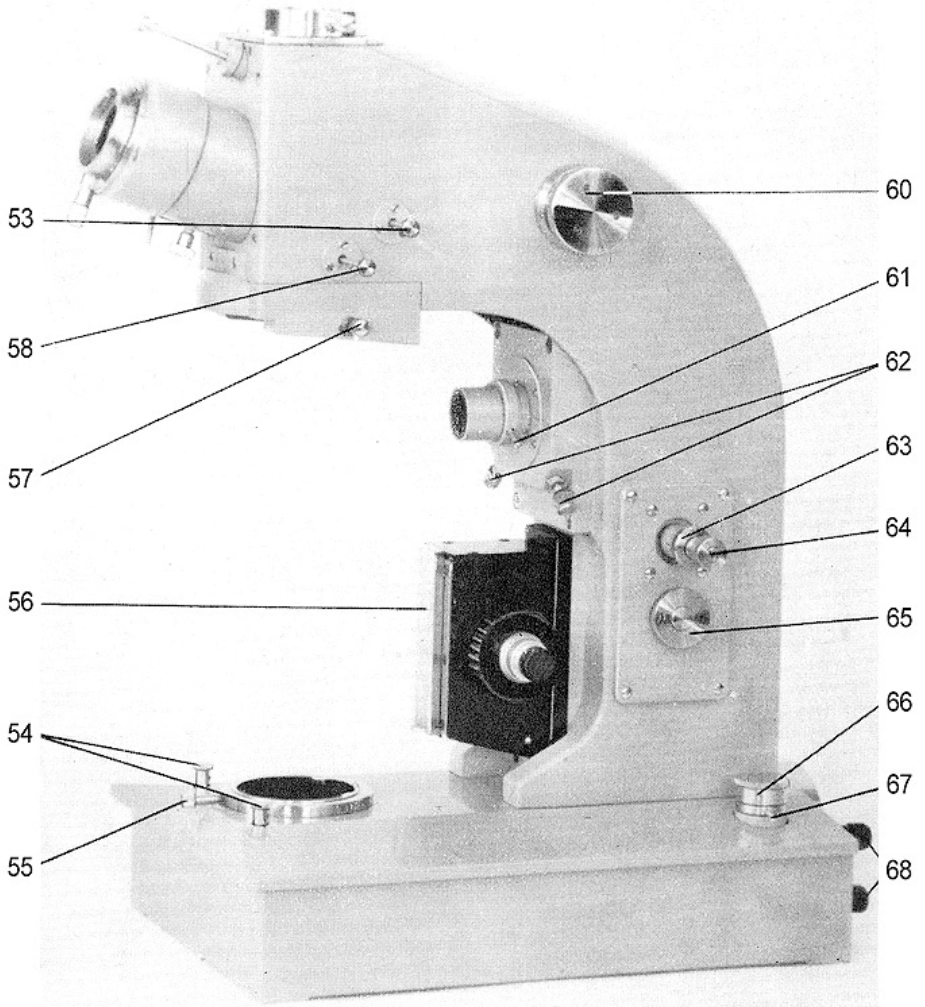

Bild 10

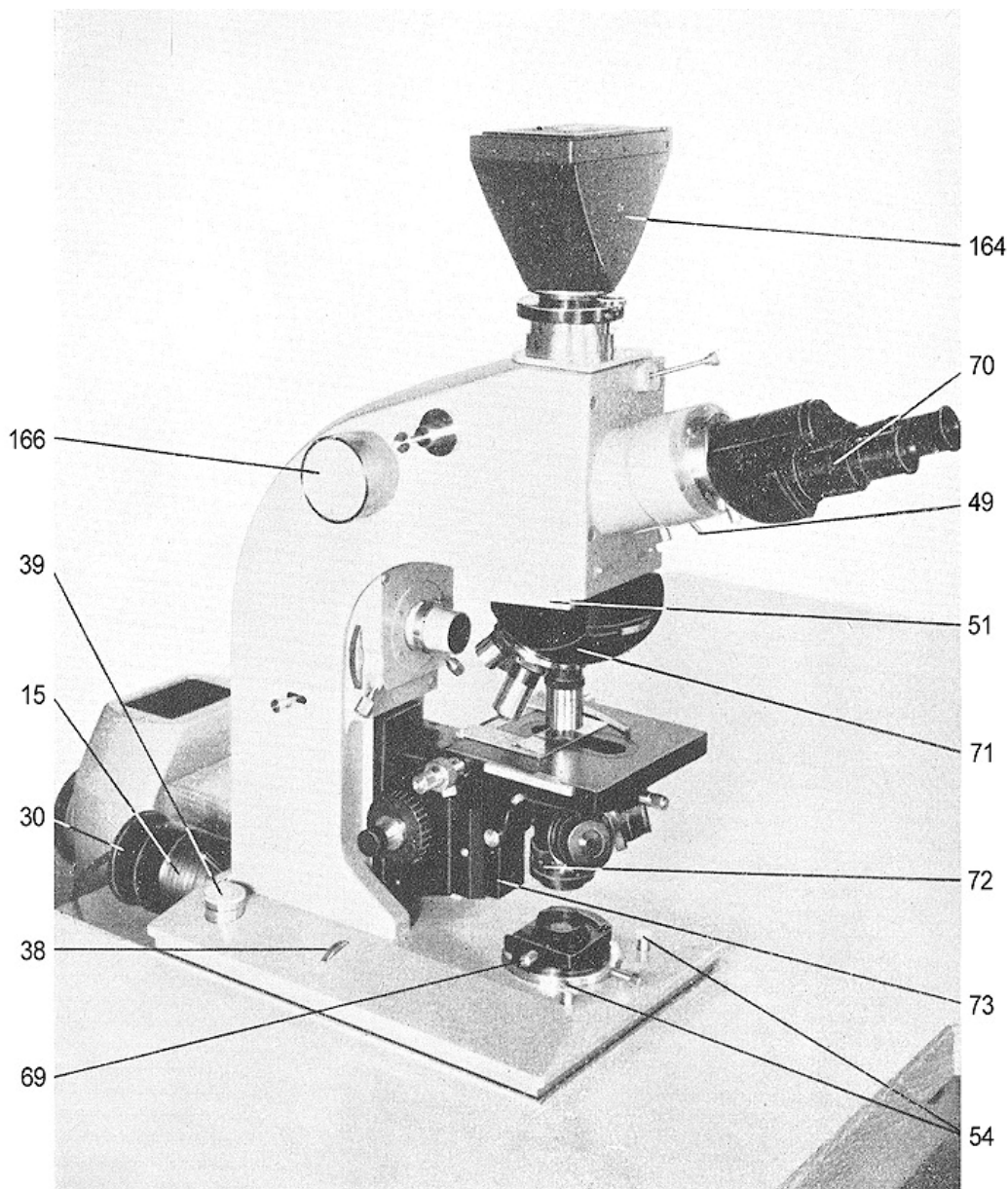

Bild 11

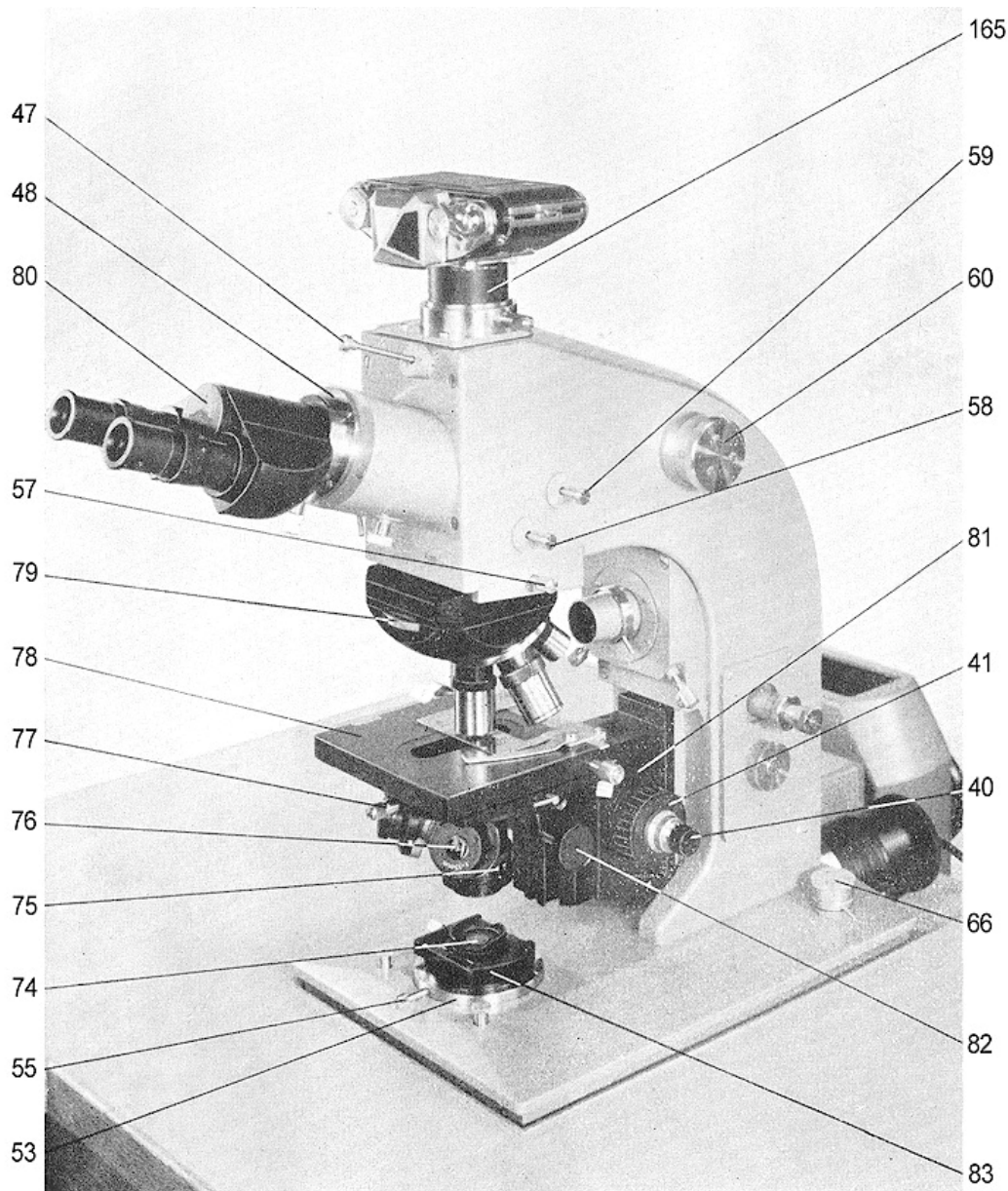

Bild 12

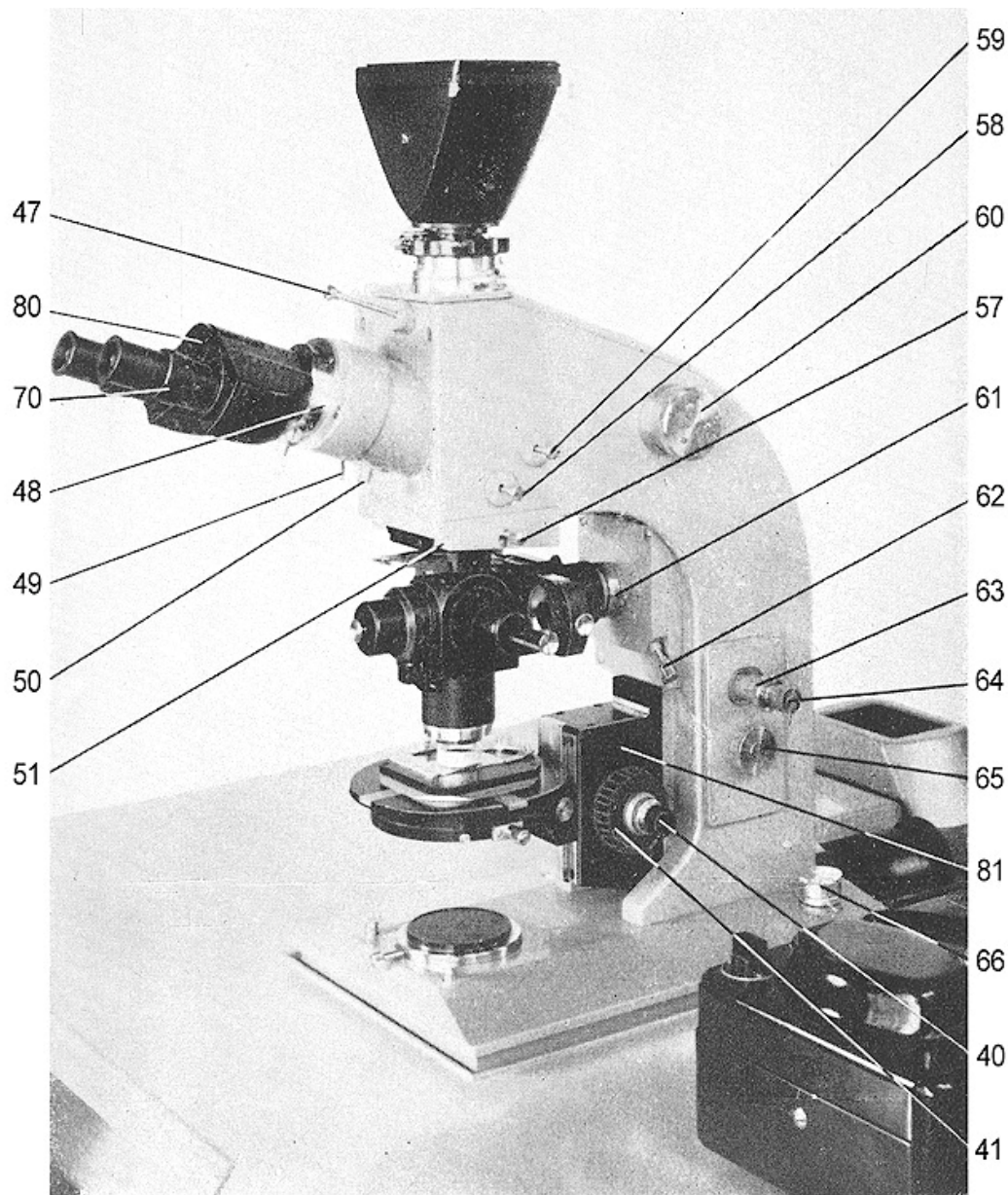

Bild 13

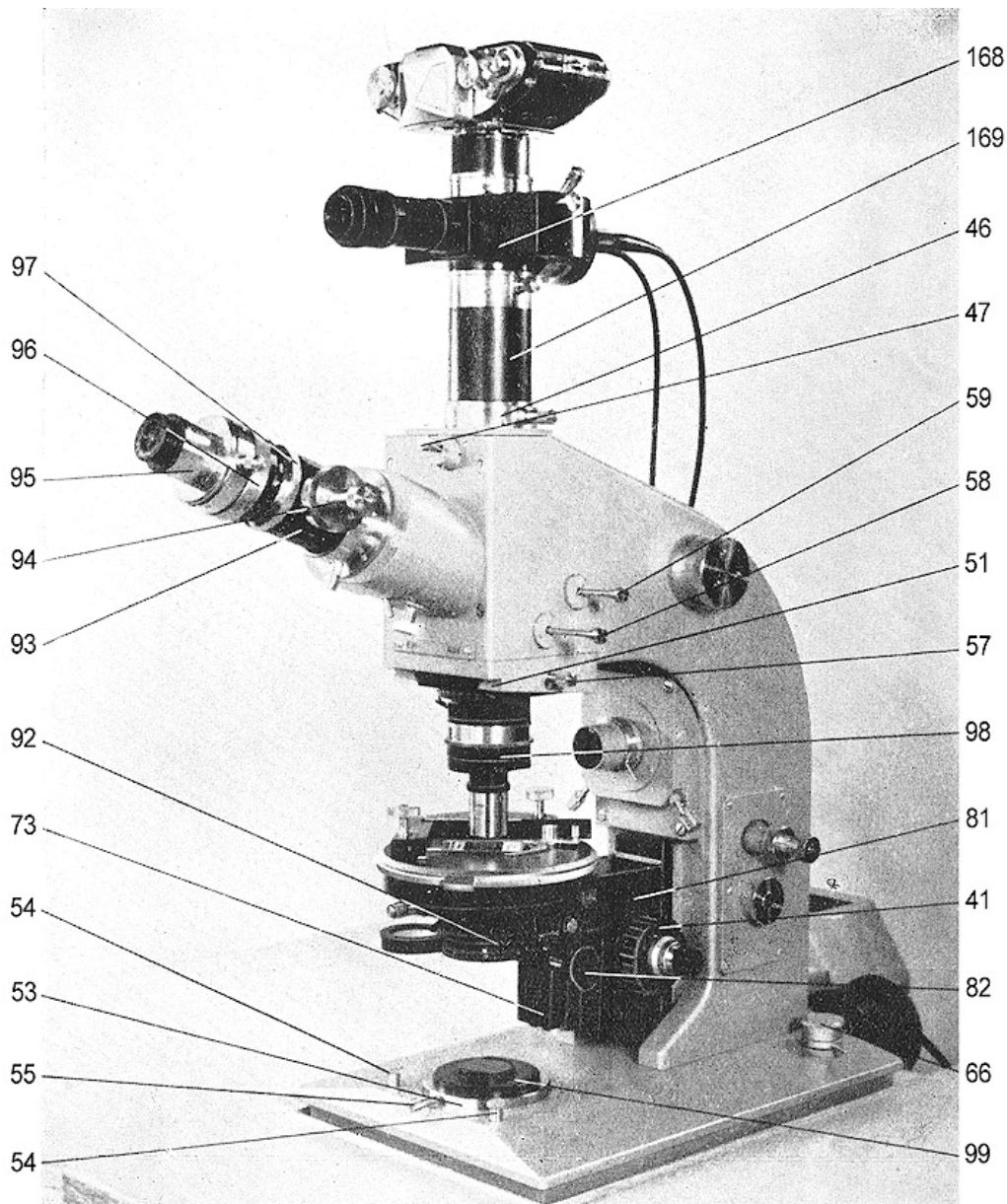

Bild 14

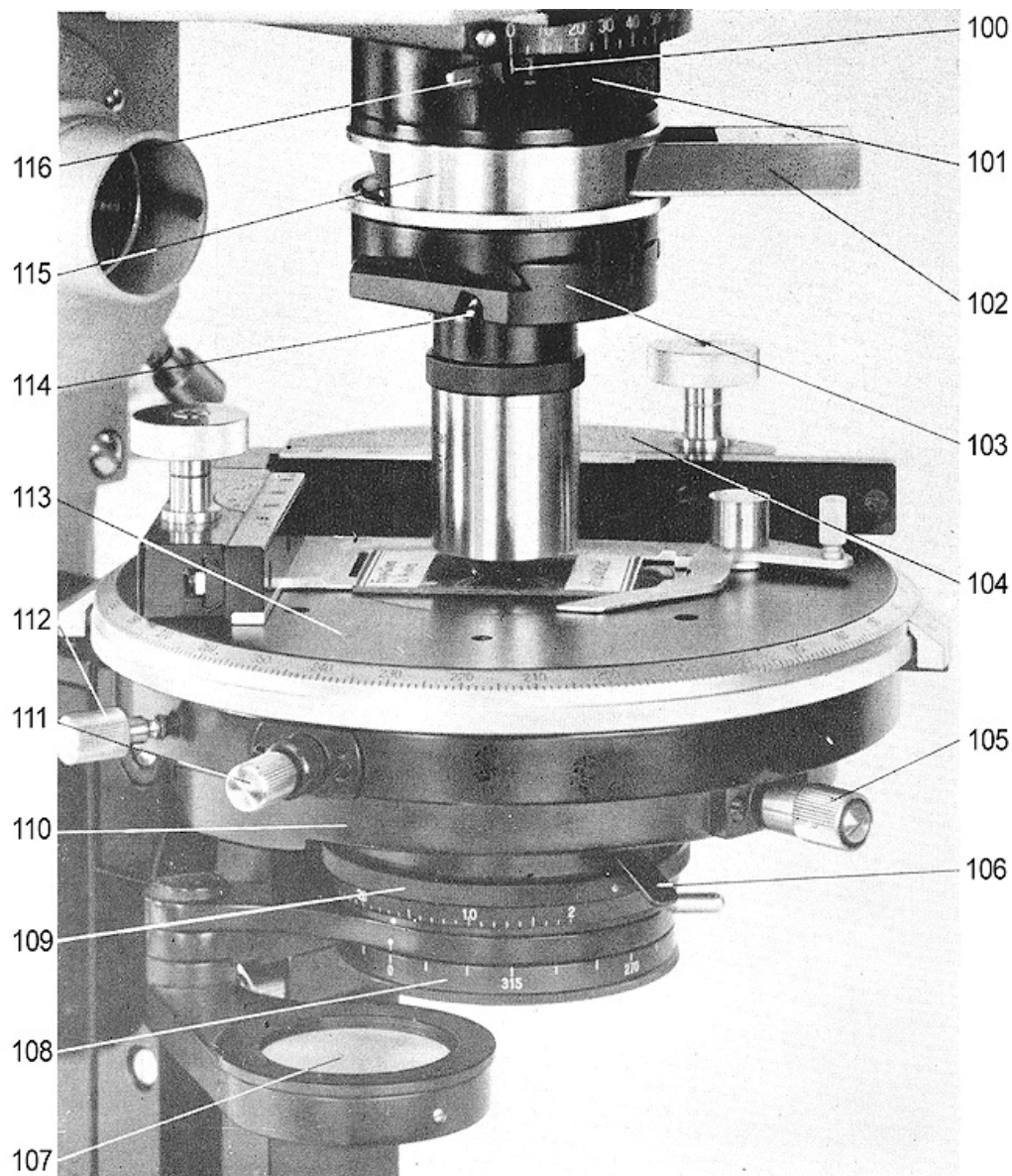

Bild 15

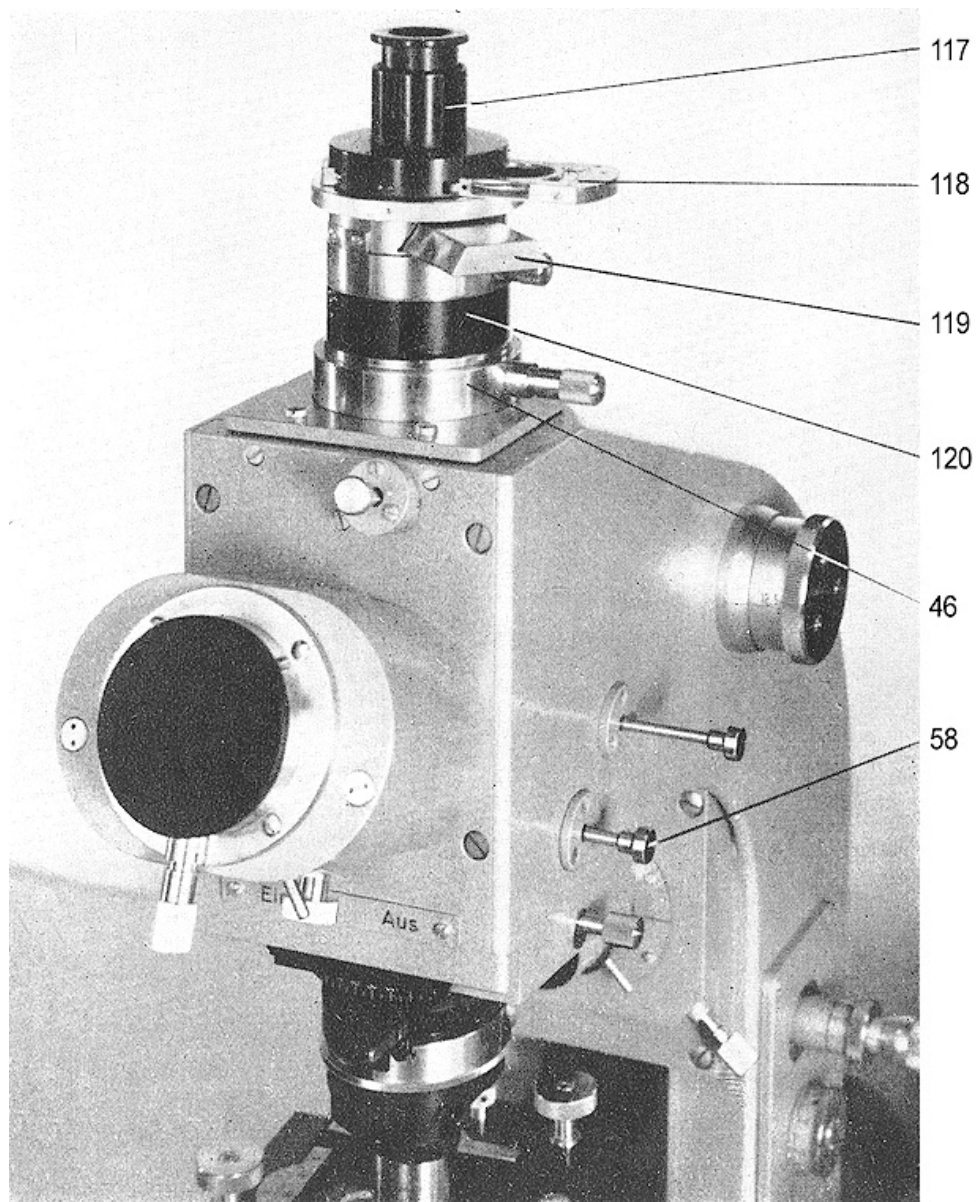

Bild 16

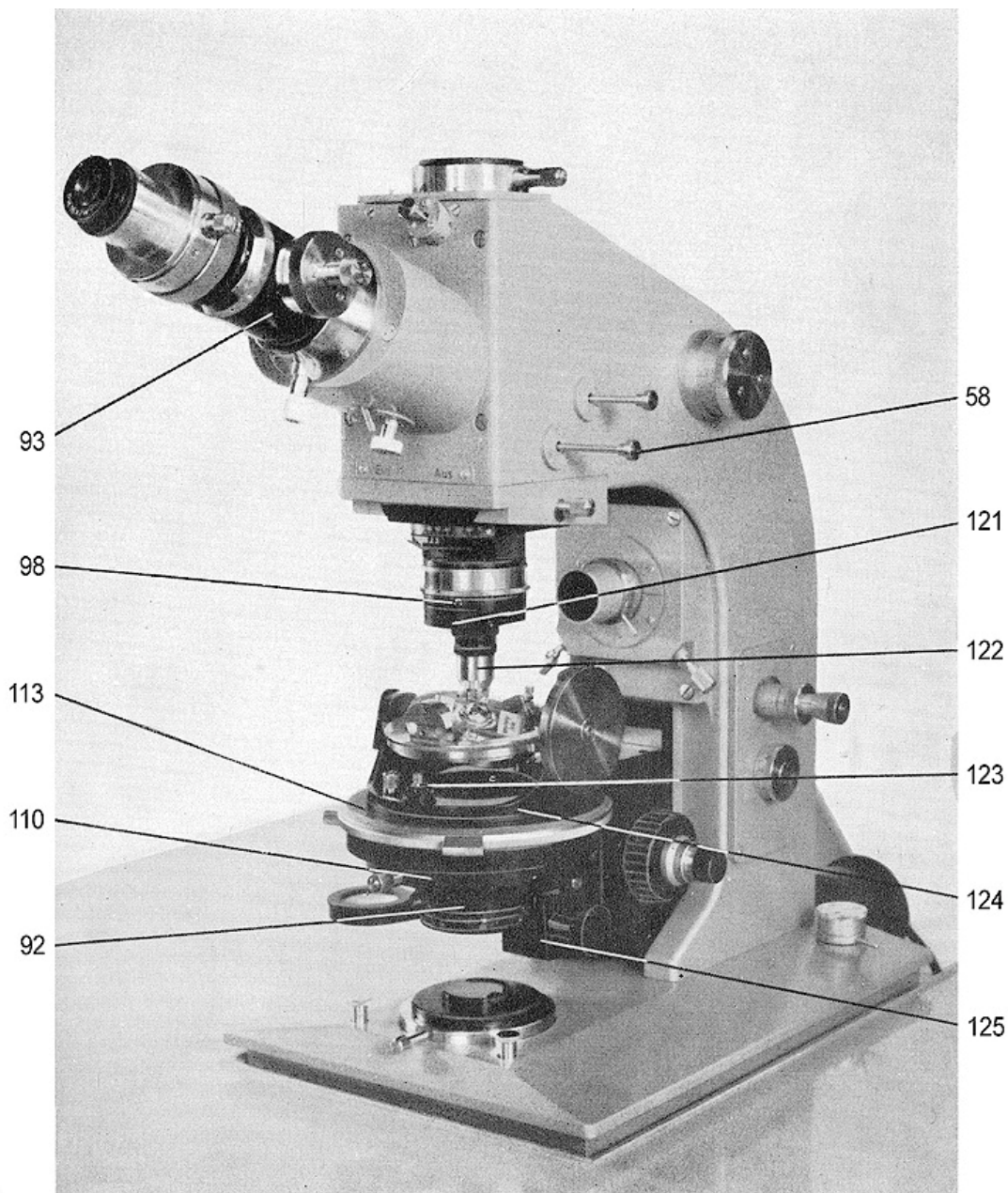

Bild 17

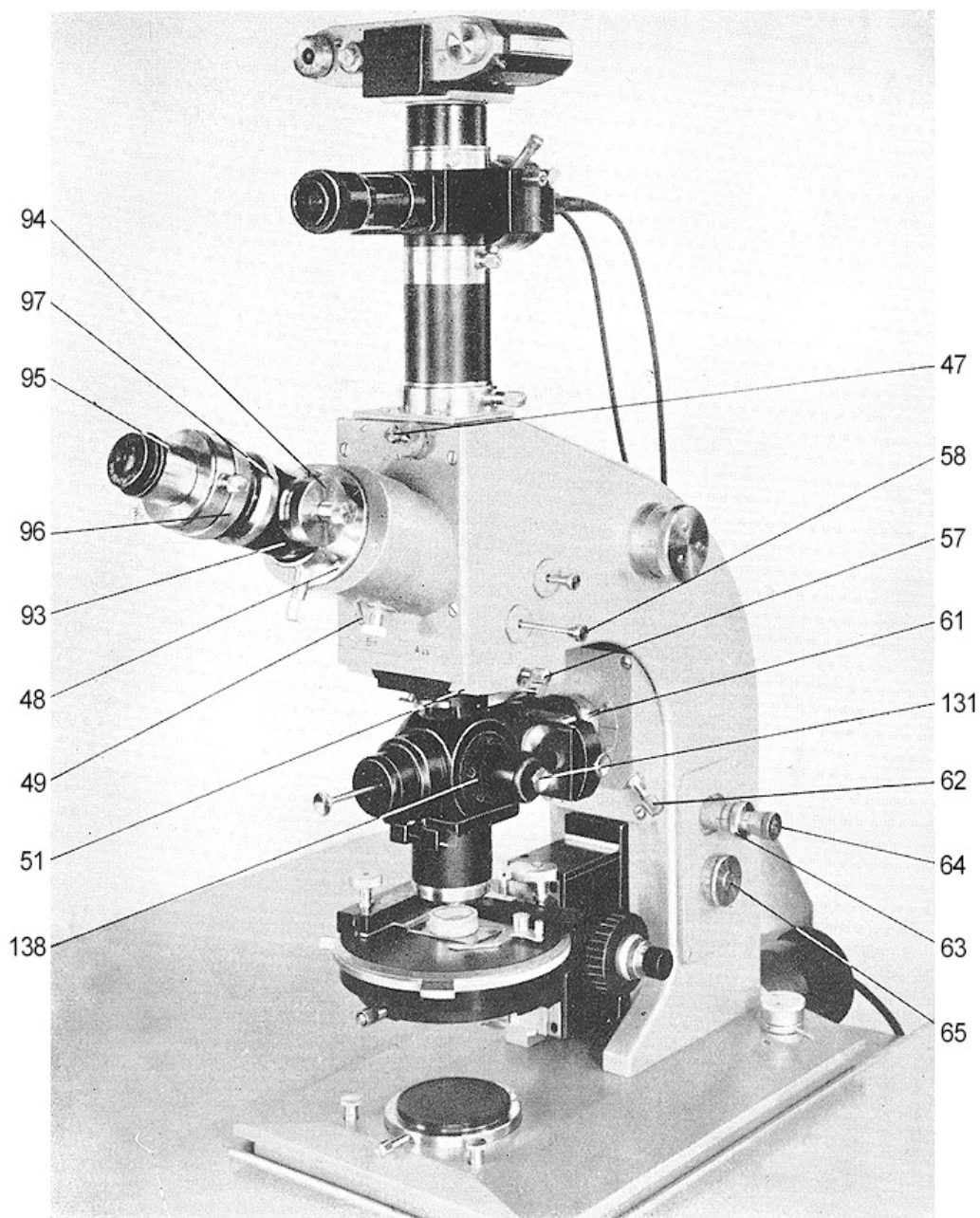

Bild 18

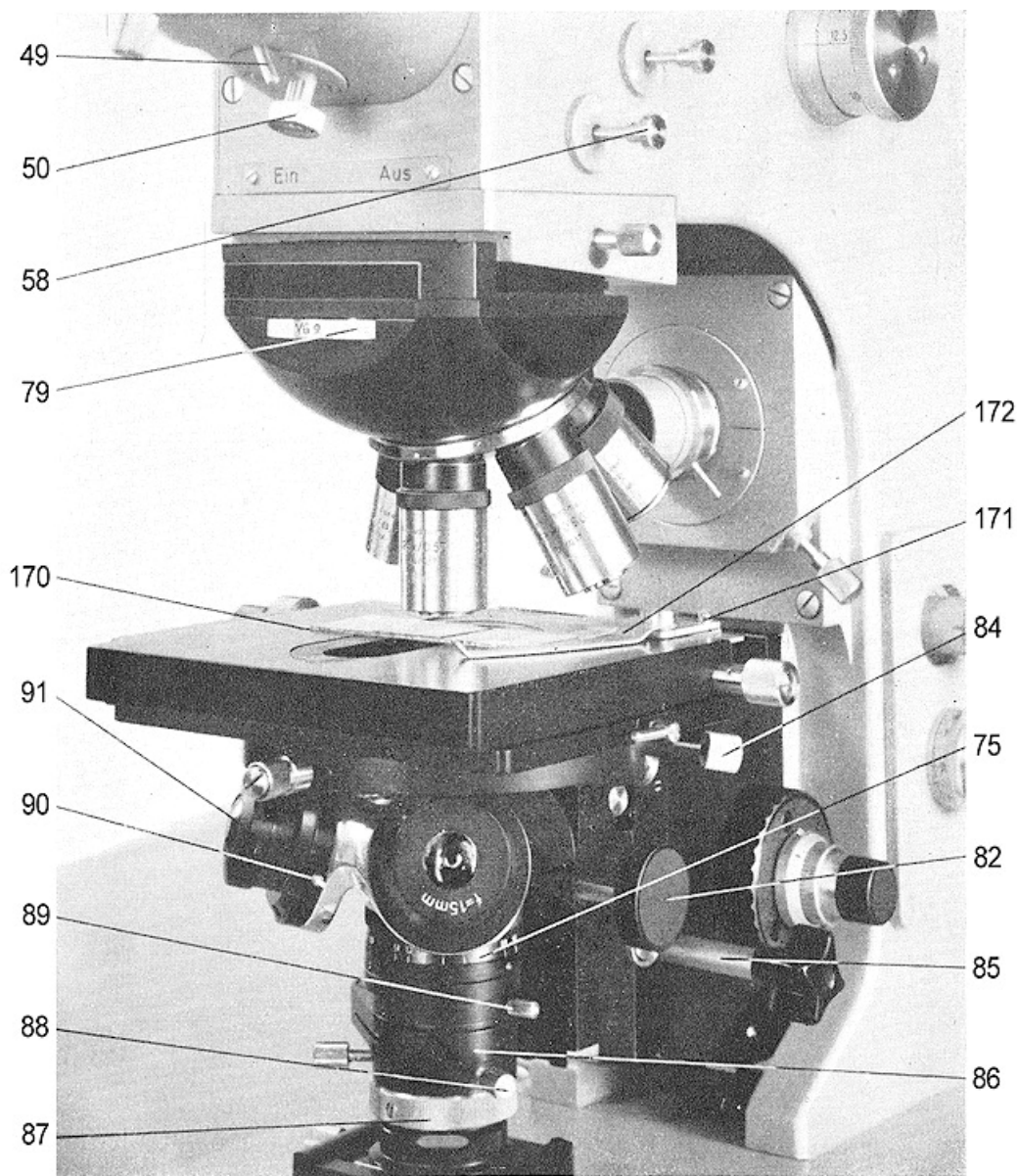

Bild 19

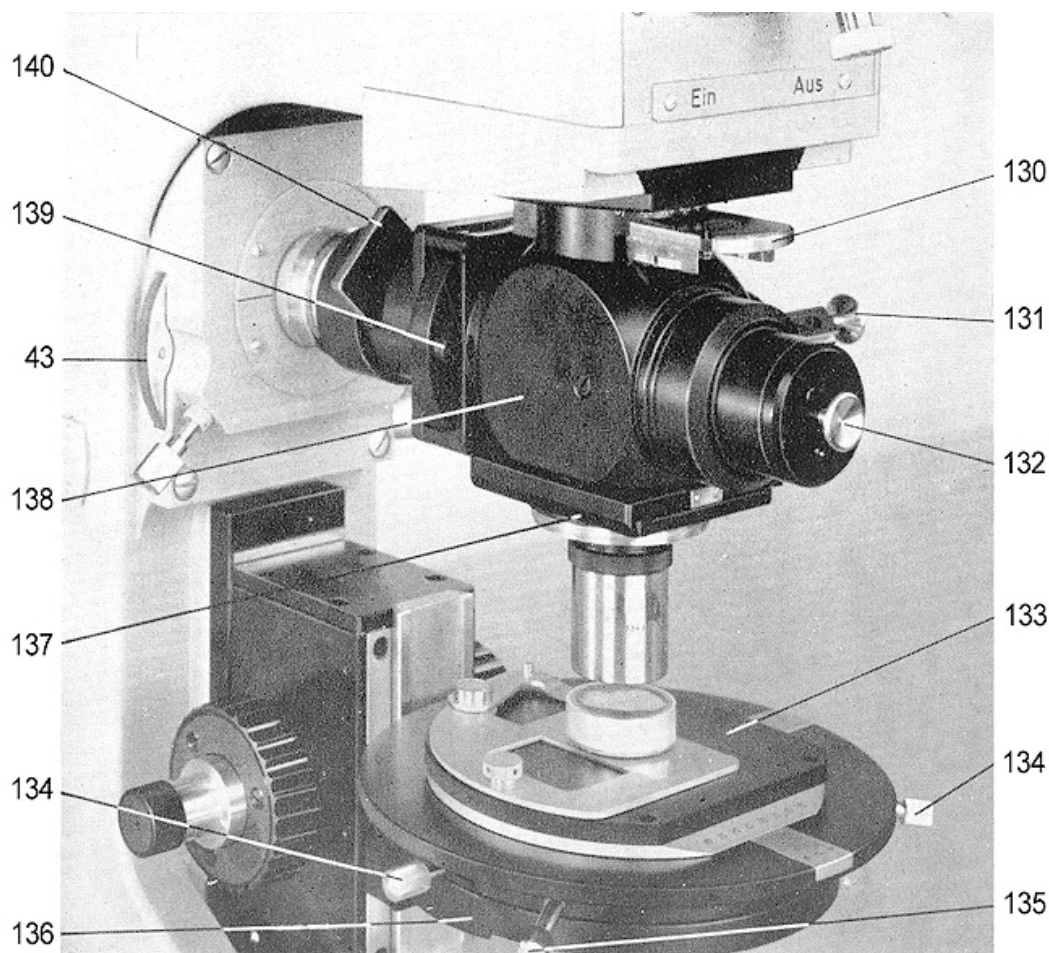

Bild 20

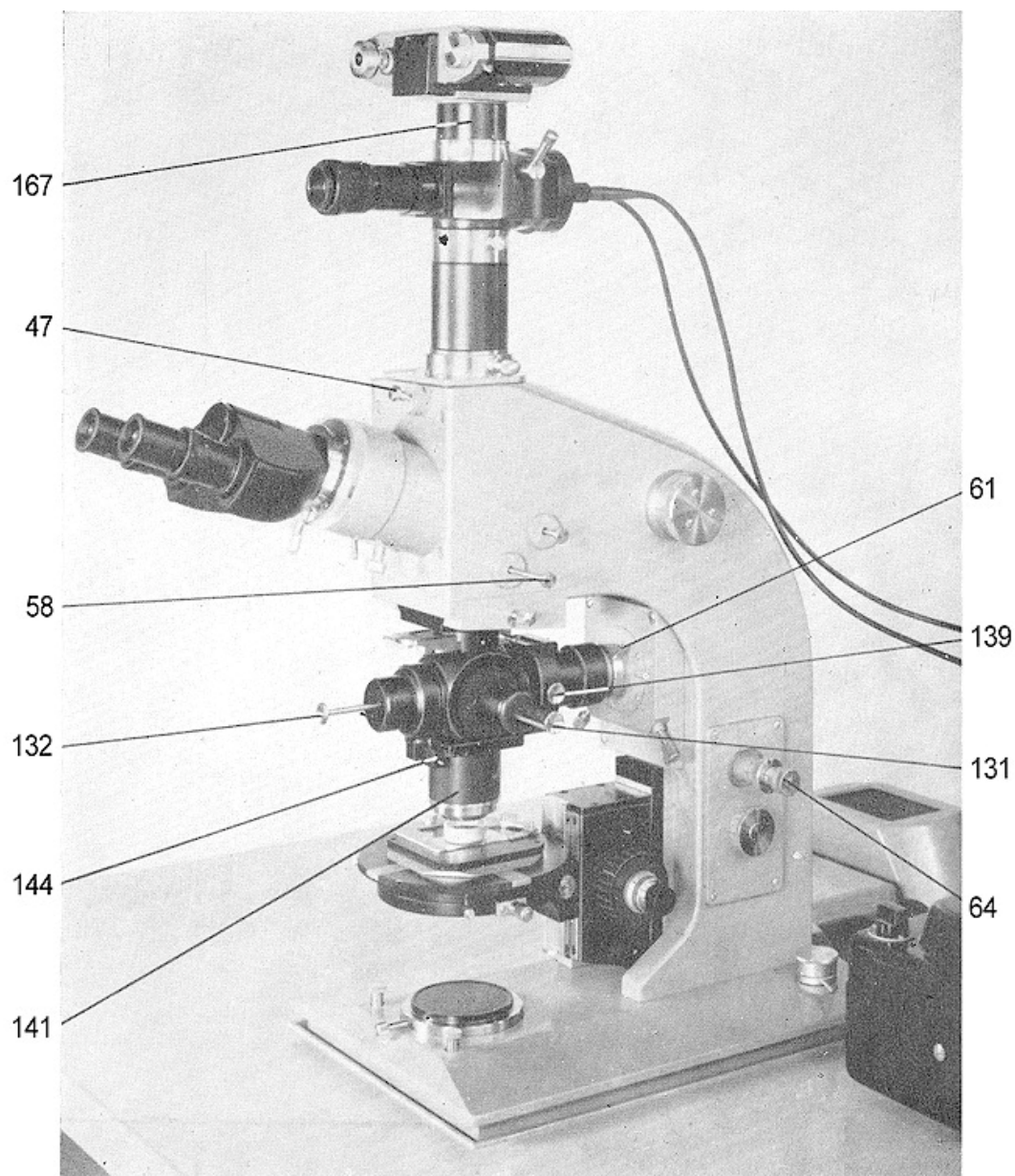

Bild 21

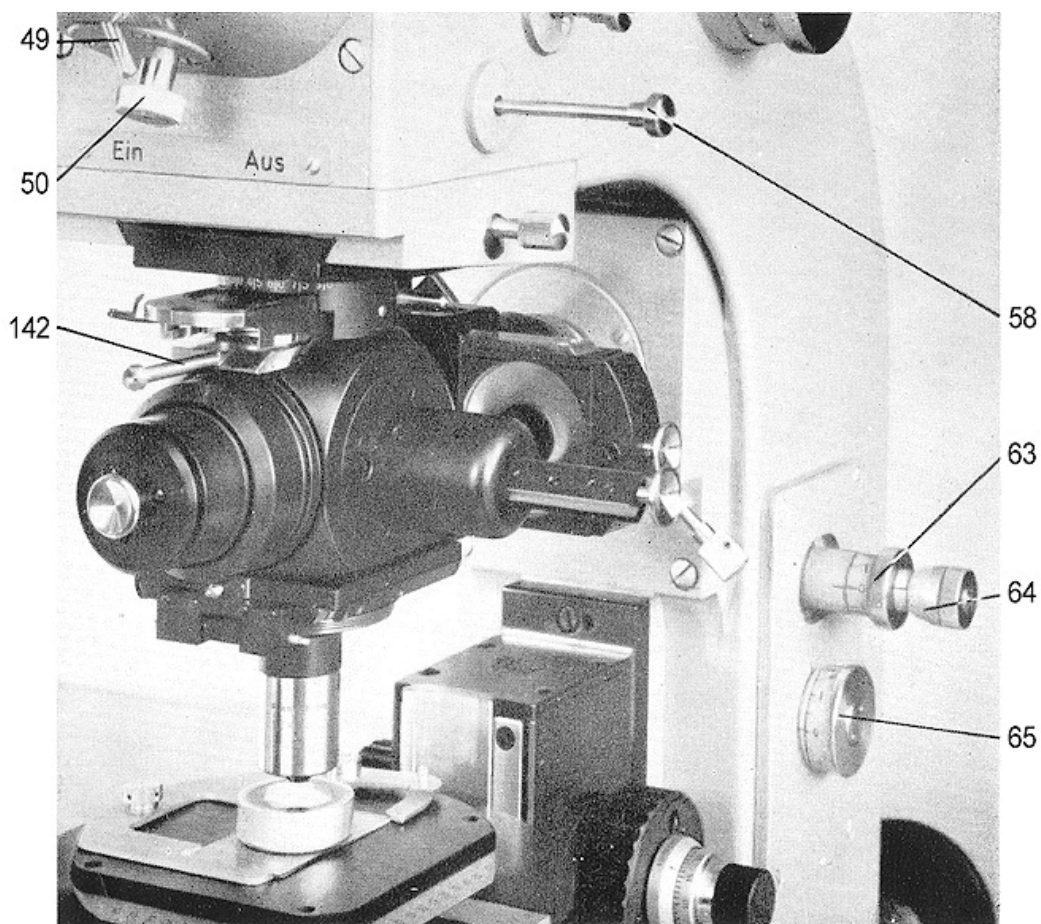

Bild 22

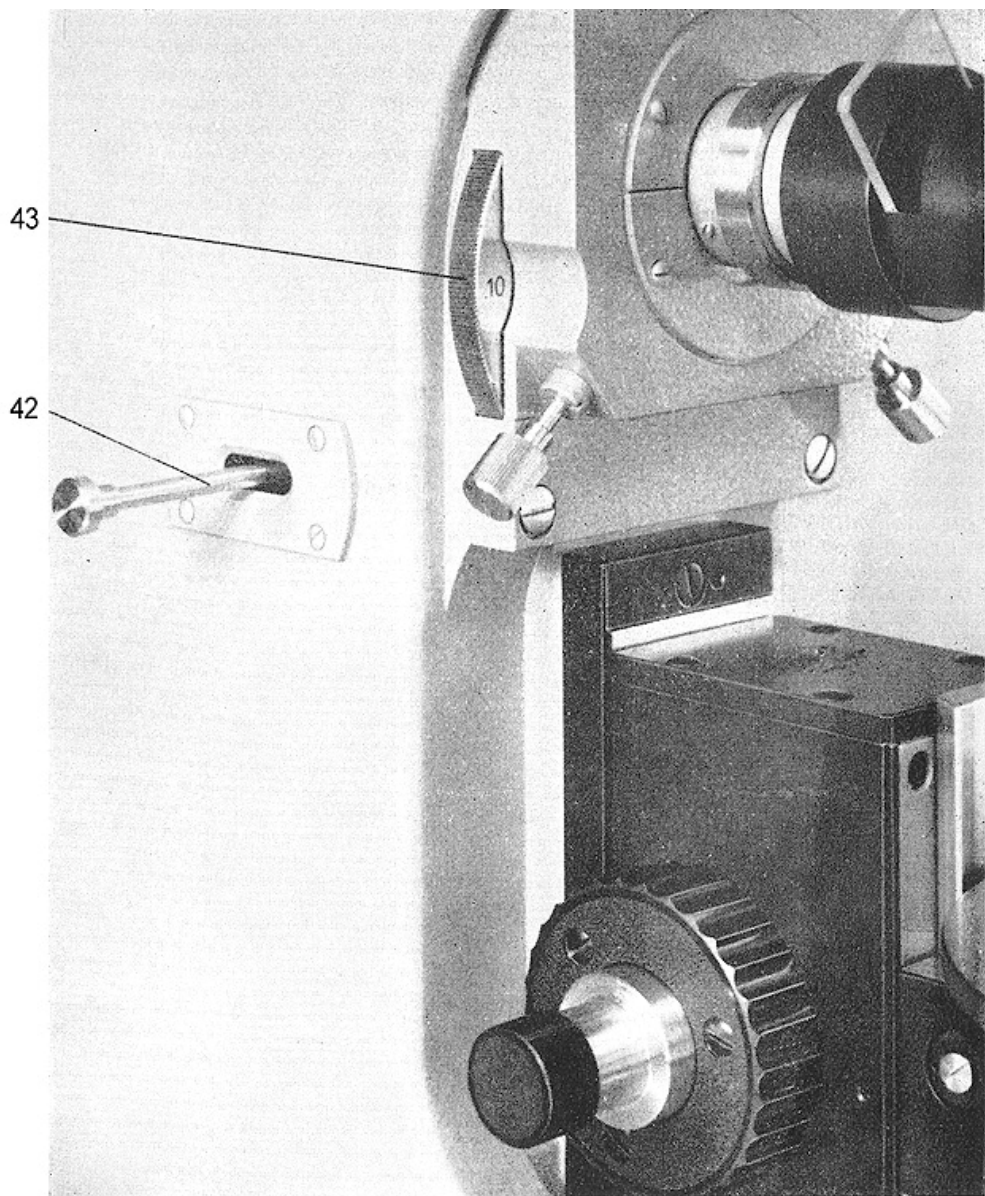

Bild 23

147

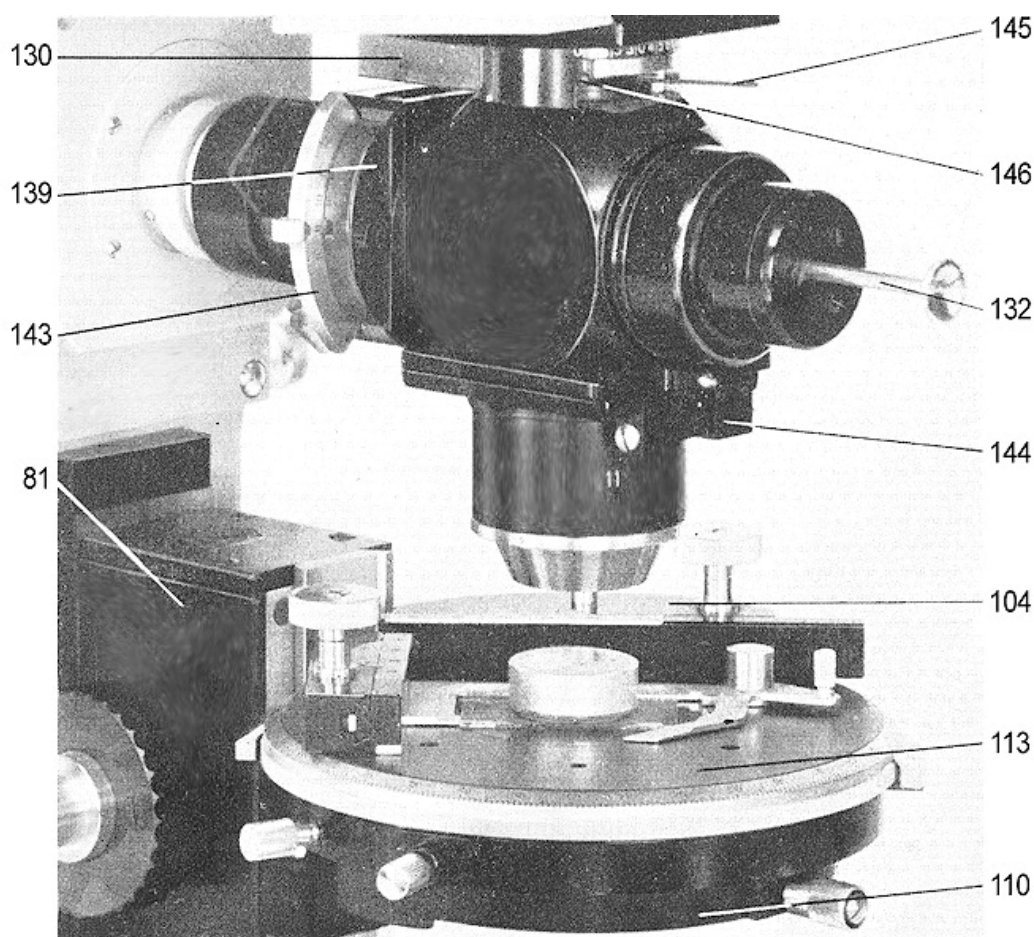
58

140

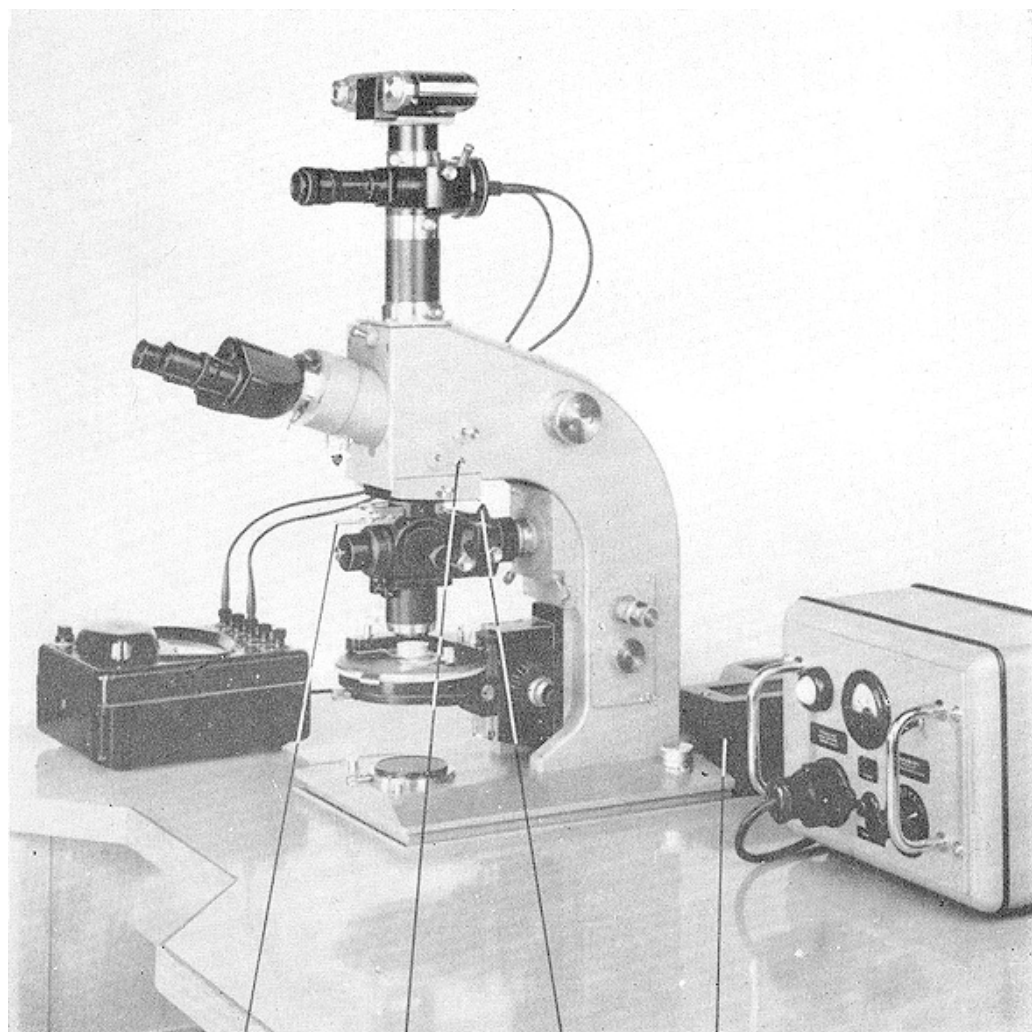
37



Bild 24



Bild 25

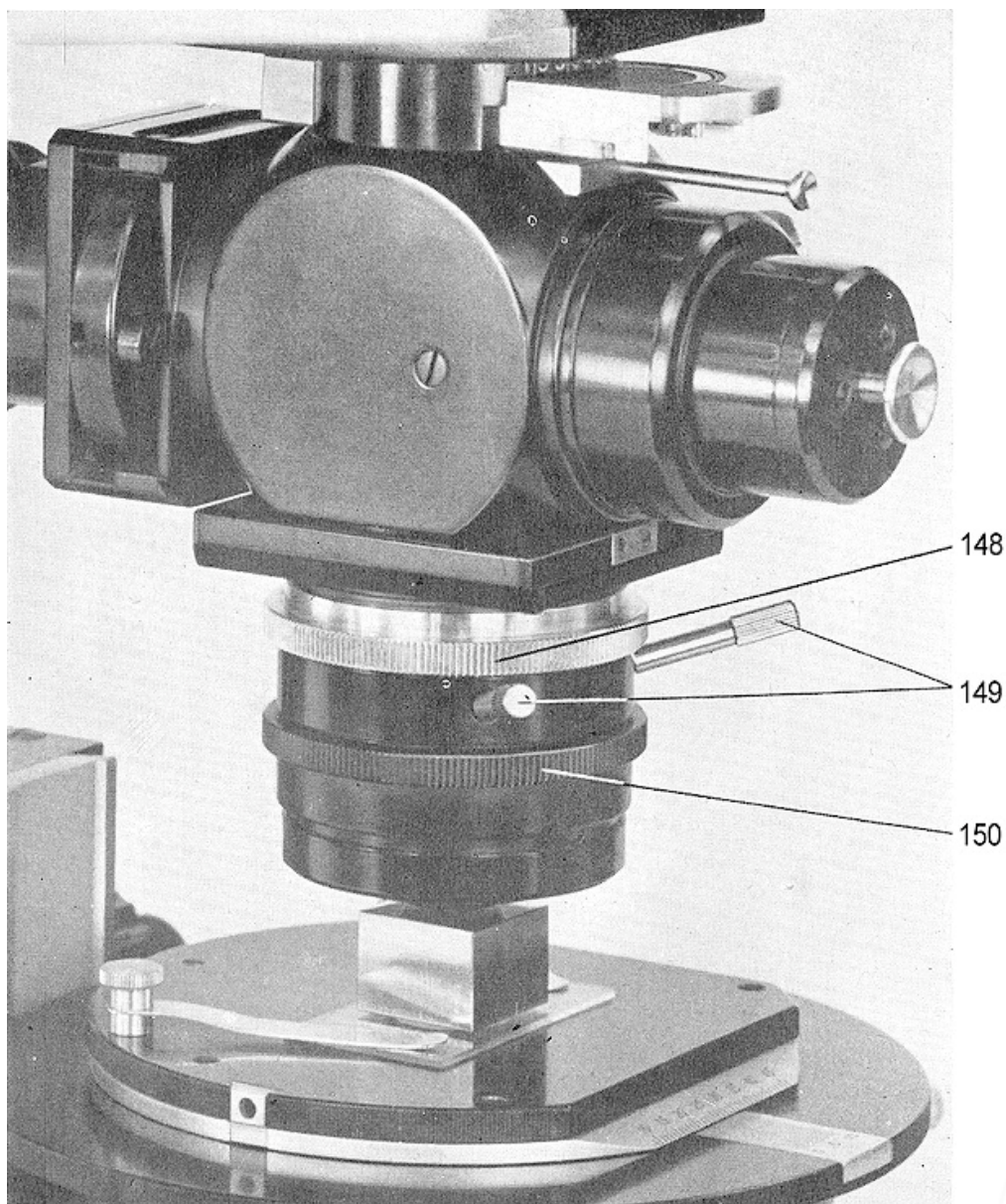

Bild 26

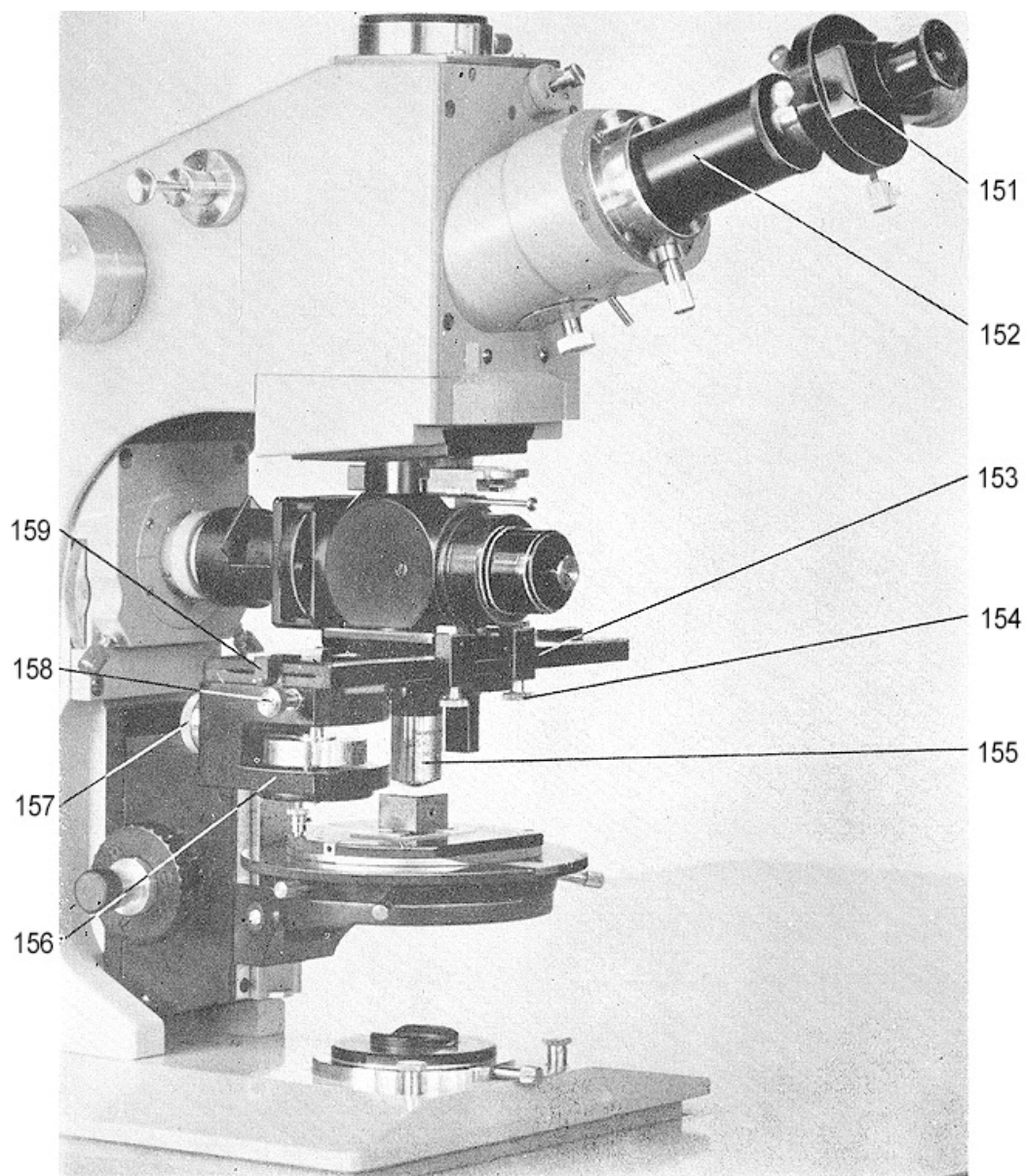

Bild 27



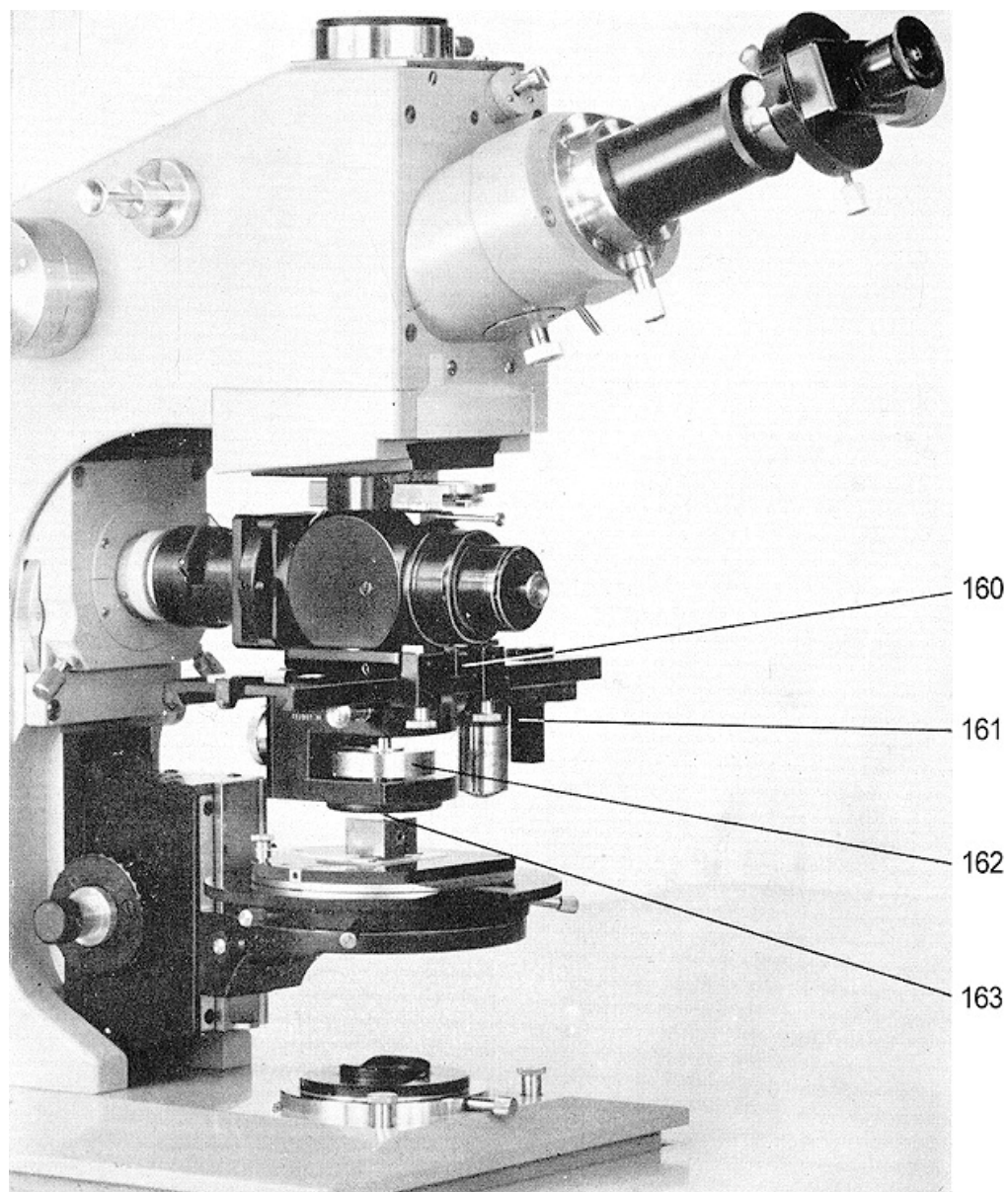

Schubkasten 2

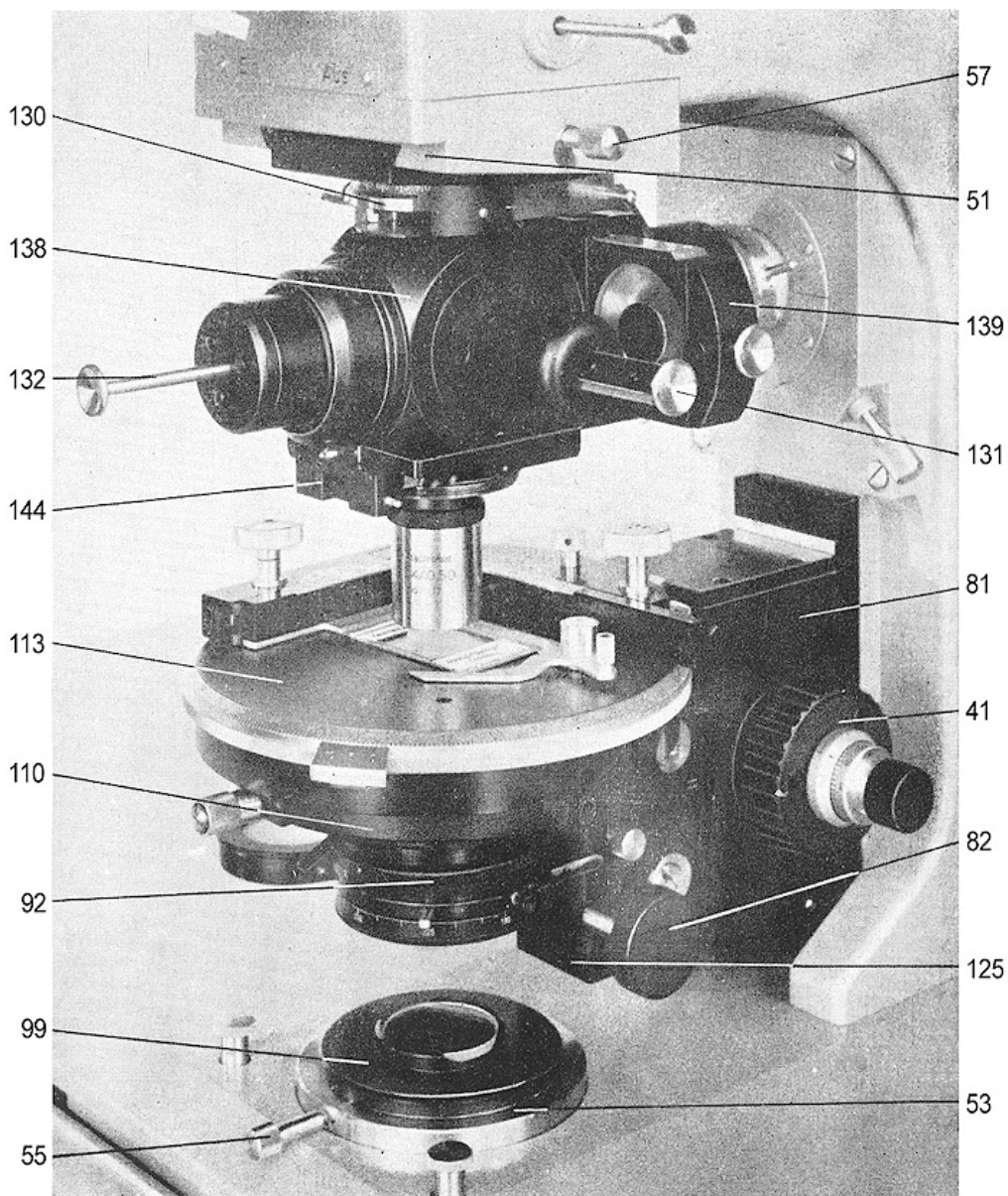
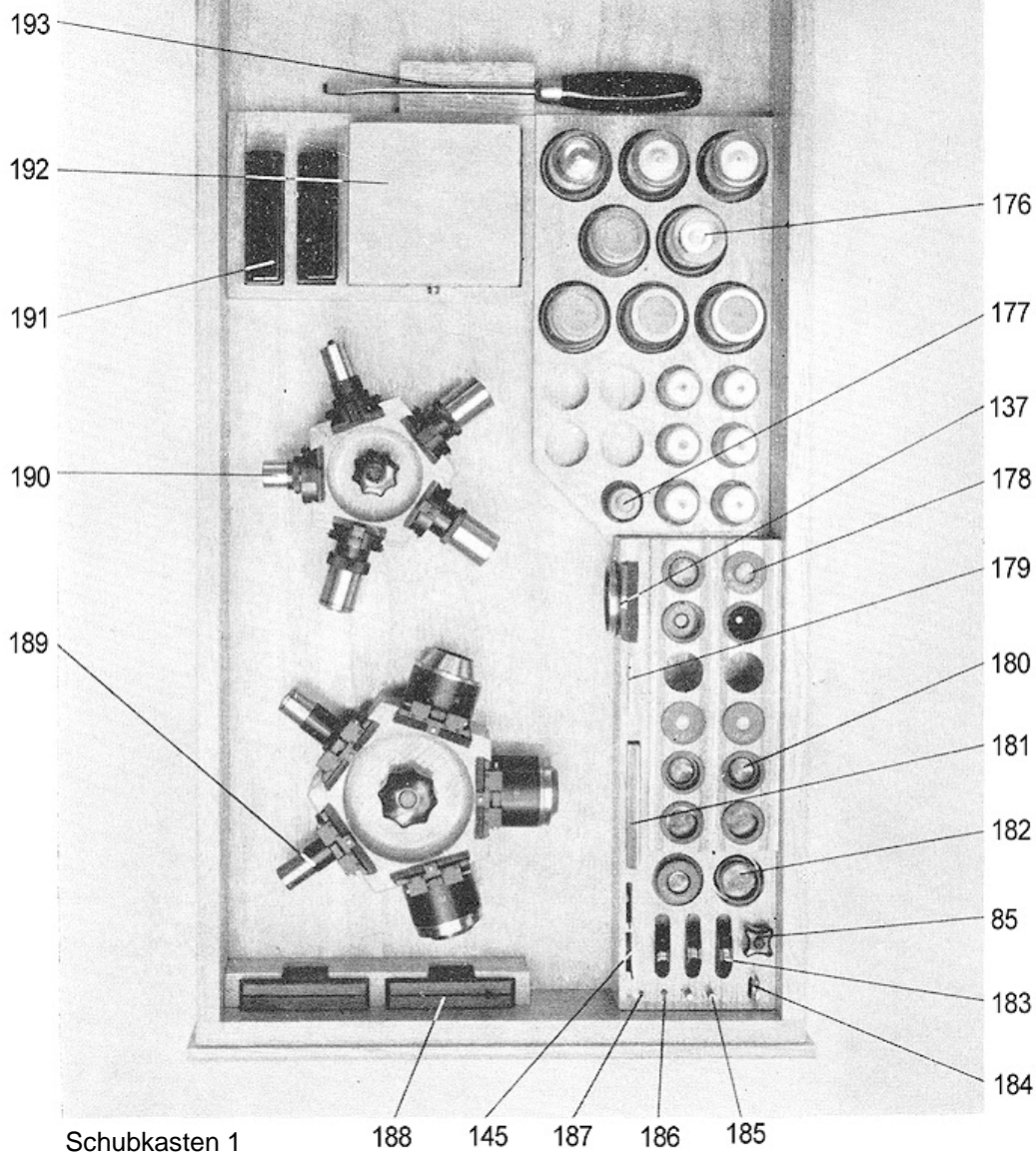
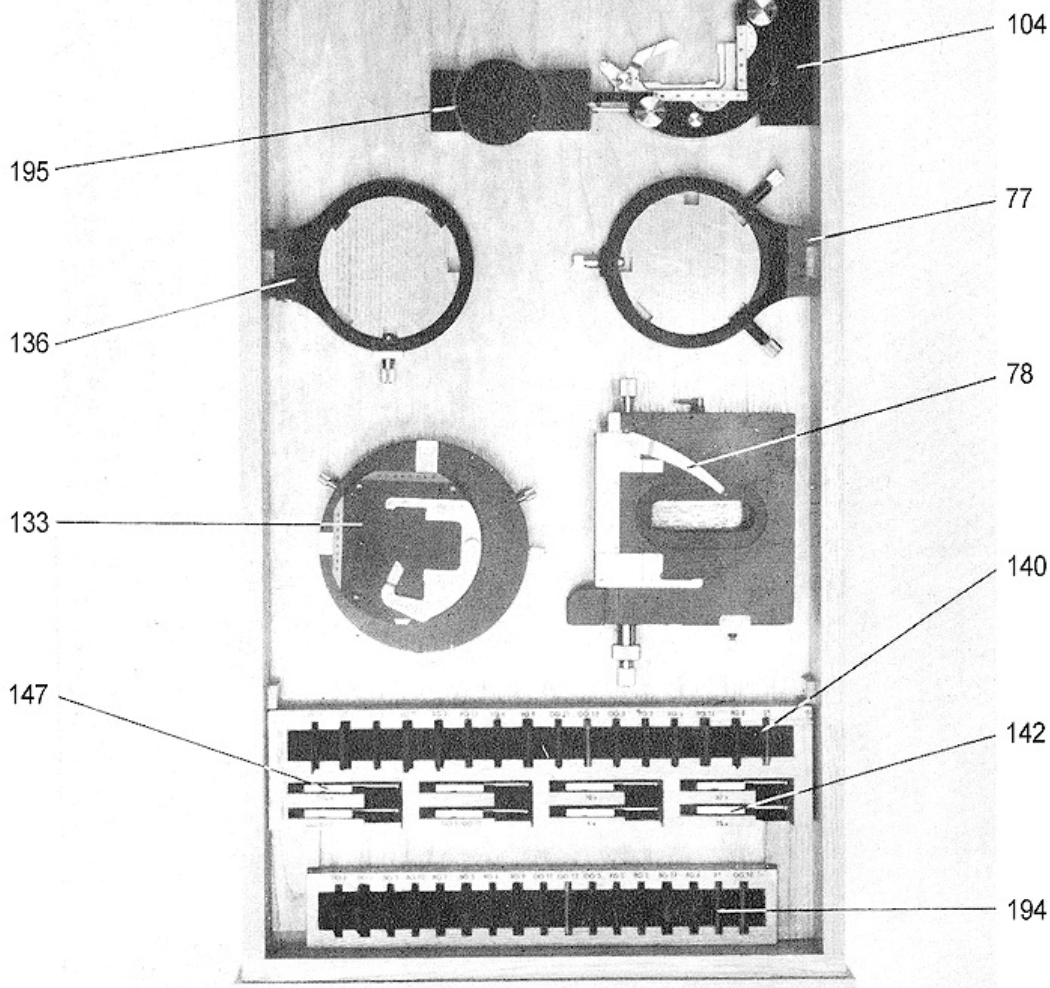
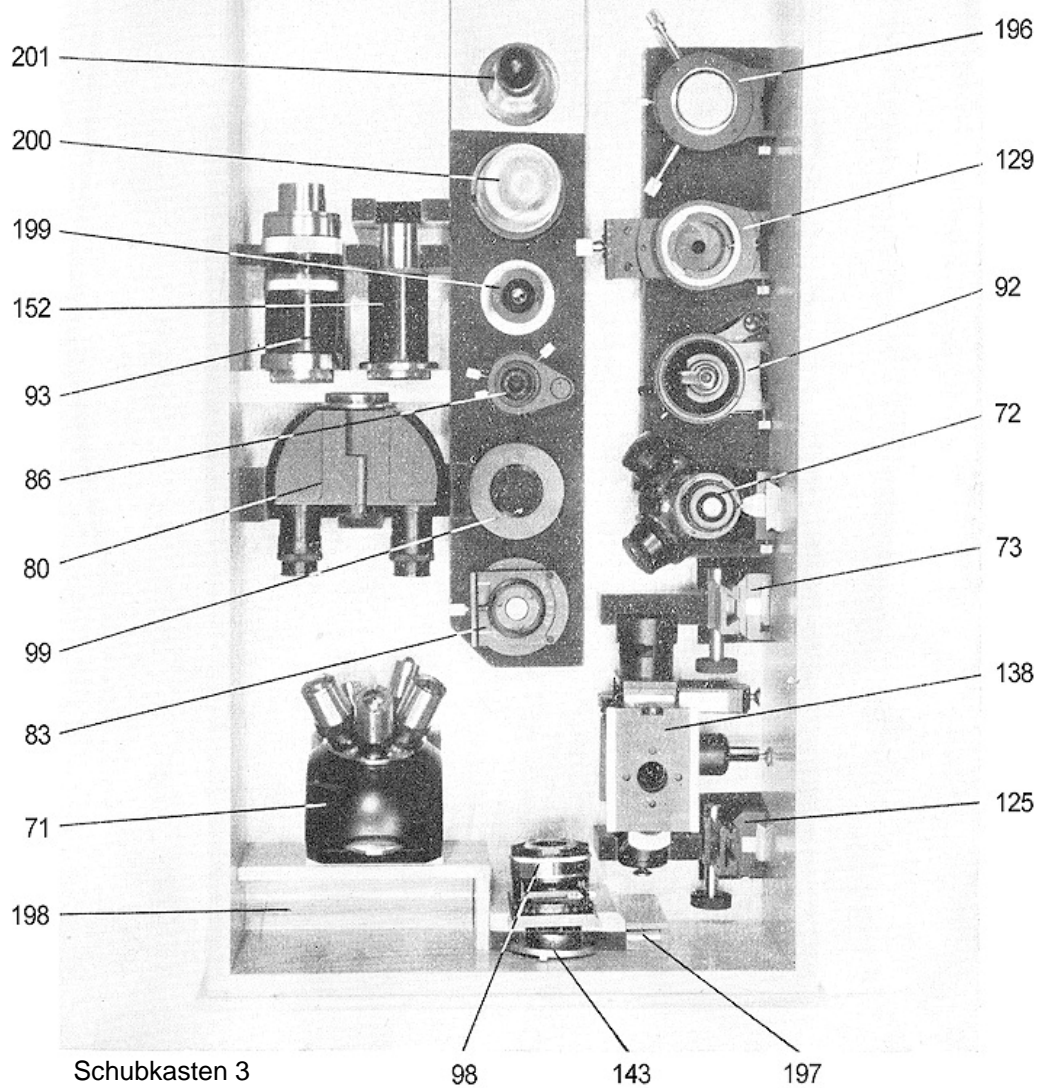

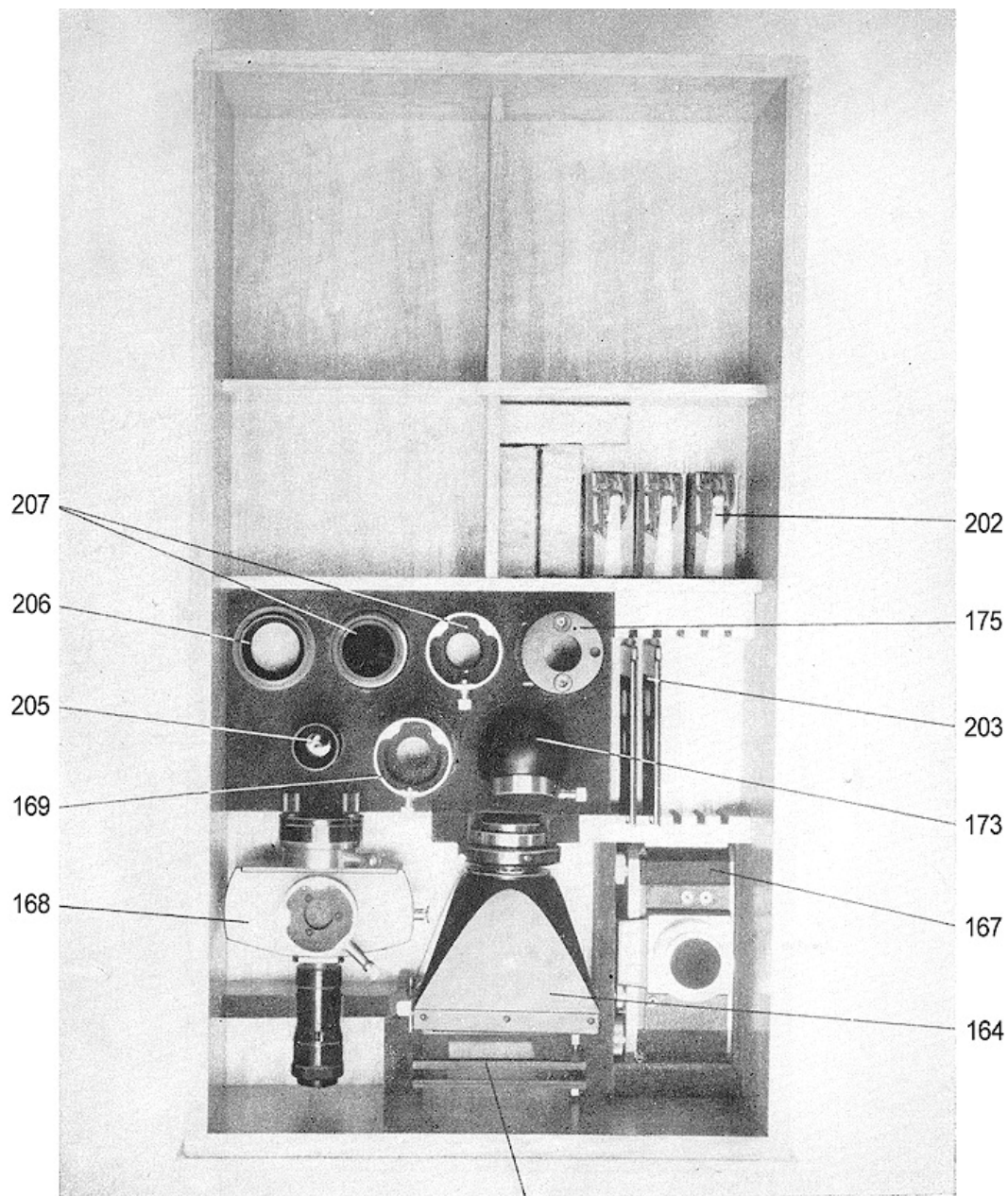

Schubkasten 4

204

